



भारतीय विज्ञान शिक्षा एवं अनुसंधान संस्थान तिरुवनंतपुरम
INDIAN INSTITUTE OF SCIENCE EDUCATION AND RESEARCH THIRUVANANTHAPURAM
IISER TVM

(An Autonomous Institute under MHRD, Government of India)
Maruthamala.P.O.,Vithura, Thiruvanathapuram-695551 Kerala, India.

Tel : 0471 – 2778039/8036

Dated:25/10/2019

CORRIGENDUM

SUB: Landscaping works under Phase-1 for IISER TVM campus,Thiruvananthapuram

REF: IISER-T/1401-2/17/2019-20 dated: 24-10-2019

With reference to the Notice inviting E-tender above for the subject work, the drawings in this regard is uploaded along with the tender document. Also, the name of work in page no.15 and 19 may be read as "Landscaping works under Phase-1 for IISER TVM campus,Thiruvananthapuram".

All other terms and conditions in the tender remains same.

A handwritten signature in black ink, followed by the date '25.10.19' written in a similar style.

**Superintending Engineer(Civil)
IISERTVM**



**INDIAN INSTITUTE OF SCIENCE EDUCATION AND RESEARCH
(IISER) THIRUVANANTHAPURAM**

VOLUME I: TENDER CONDITIONS

**NAME OF WORK: Landscaping works under Phase-1 for IISER TVM
campus, Thiruvananthapuram**

NIT NUMBER: IISER-T/1401-2/17/2019-20 dated: 23-10-2019

Index

Name of work: Landscaping works under Phase-1 for IISER TVM campus, Thiruvananthapuram

NIT Number: IISER-T/1401-2/17/2019-20 dated: 23-10-2019

Sl. No	Item	Page Nos
1	e- Tender press notice	2 - 6
1(i)	Section-I – i) Notice inviting e-tender	7 - 14
1(ii)	ii) Additional information to the applicants	15 - 16
2	Letter of transmittal	17
3	Integrity agreement	18 - 24
5	CHECK LIST: (Details of Enclosures.)	25
6	Section-II-Item Rate Tender & contract for works	26 - 29
7	Form of Earnest Money Deposit Bank Guarantee Bond	30
8	Form of Performance (Guarantee) Bank Guarantee Bond	31-32
9	Proforma of agreement	33-34
10	Proforma bank guarantee in lieu of bid security	35-37
11	Appendix- Clause 25	38
12	Proforma of Schedules A to C	39-45
13	List of approved makes	45
14	Volume-II: Drawing	
15	Volume III – Financial Bid	



INDIAN INSTITUTE OF SCIENCE EDUCATION AND RESEARCH THIRUVANANTHAPURAM

(An Autonomous Institution, Ministry of Human Resource Development, Govt. of India)

Near Jersey Farm, Maruthamala P.O, Vithura, Pin:

695551, Trivandrum, Kerala, India.

Tel: +91-0471-2778039/8036

Website: www.iisertvm.ac.in

Tender NOTICE INVITING e-TENDER (e-Procurement mode)

Indian Institute of Science Education and Research, THIRUVANANTHAPURAM invites online ITEM rate bids in open bid system from approved and eligible contractors registered with CPWD, State PWDs, MES or agencies who have executed works of similar nature and magnitude, found eligible as per clause 2 & 3 of NIT for the work mentioned below:

Brief Details of Tender:

Sr. No.	Description of work in Brief	Approx. Estimated cost put to bid (Rs.)	Earnest Money Deposit (Rs.)	Period of Completion	Last date & time of online submission of bid	Time & date of opening of bids
1	2	3				
1	Landscaping works under Phase-1 for IISER TVM campus, Thiruvananthapuram	20,85,684/-	41,714/-	2 months	31-10-2019 16.00 hrs	01-11-2019 16.00 hrs

The Tender Document can be downloaded from Central Public Procurement (CPP) Portal <https://eprocure.gov.in/eprocure/app> or Institute website www.iisertvm.ac.in and bid is to be submitted online only through the E-procurement portal up to the last date and time of submission of tender.

Critical Dates of Tender

Sr.No	Particulars	Date	Time in hrs.
1	Date of Online Publication	23-10-2019	17.00
2	Bid Submission Start Date	24-10-2019	10 00
3	Bid Submission Close Date	31-10-2019	16 00
4	Closing date & time for Submission of EMD	31-10-2019	16 00
5	Opening of Technical bids	01-11-2019	16 00

No manual bids will be accepted. All quotation (both Technical and Financial should be submitted in the E-procurement portal).

Any queries relating to the process of online bid submission or queries relating to CPP Portal in general may be directed to the 24x7 CPP Portal Helpdesk. The contact number for the helpdesk is 0120-4200462, 0120-4001002, and 91-8826246593. 0120-4001 062, 0120-4001 005, 0120-6277 787

1) **Information & Instructions for Online Bid Submission:**

This tender document has been published on the Central Public Procurement Portal ([URL:https://eprocure.gov.in/eprocure/app](https://eprocure.gov.in/eprocure/app)) & Institute website www.iisertvm.ac.in. The bidders are required to submit soft copies of their bids electronically on the CPP Portal, using valid Digital Signature Certificates. The instructions given below are meant to assist the bidders in registering on the CPP Portal, prepare their bids in accordance with the requirements and submitting their bids online on the CPP Portal. More information useful for submitting online bids on the CPP Portal may be obtained at: <https://eprocure.gov.in/eprocure/app>.

- 1.1 The intending bidder must read the terms and condition of NIT carefully. Bidder should submit his bid only if he considers himself eligible and he is in possession of all the required documents.
- 1.2 Bid documents should be submitted online complete in all respect along with requisite amount of tender fee (cost of bid documents). Cost of tender documents shall be remitted to IISER TVM by online payment through **State Bank Collect**. Complete set of tender documents comprising **Volume I, II** has been made available at e-tender portal ([URL:https://eprocure.gov.in/eprocure/app](https://eprocure.gov.in/eprocure/app))
- 1.3 The bidder would be required to register at e-tender portal ([URL:http://eprocure.gov.in/eprocure/app](http://eprocure.gov.in/eprocure/app)) For submission of the bids, the bidder is required to have digital Signature Certificate (DSC) from one of the authorized Certifying Authorities.
- 1.4 Information and instruction for bidders posted on website shall form part of the bid document.
- 1.5 The bid document consisting of **Vol.I – Tender conditions, Vol-II- Financial Bid (BOQ)** and the set of terms and conditions of the contract to be complied with and other necessary documents can be seen and downloaded from website ([URL:https://eprocure.gov.in/eprocure/app](https://eprocure.gov.in/eprocure/app)) free of cost.
- 1.6 But the bid can only be submitted after uploading the mandatory scanned documents such as receipt of online payment towards tender fee, in favour of IISER THIRUVANANTHAPURAM, scan copies of other required documents as specified in the NIT. The tender fee should be deposited online with IISER THIRUVANANTHAPURAM within the period of bid submission as specified in the bid document.

- 1.7 Those contractors not registered on the website mentioned above, are required to get registered beforehand. If needed they can get imparted to training on online tendering process as per details available on the website. The intending bidder must have valid class-III digital signature to submit the bid.
- 1.8 On opening date, the contractor can login and see the bid opening process. After opening of bids he will receive the competitor bid sheets.
- 1.9 Contractor can upload documents in the form of JPG format and PDF format.
Certificate of Financial Turn over: At the time of submission of bid contractor may upload Affidavit/ Certificate from CA mentioning Financial Turnover of last 3 years or for the period as specified in the bid document and further details if required may be asked from the contractor after opening of technical bids. There is no need to upload entire voluminous balance sheet.
- 1.10 Contractor has to quote item rate the total estimated cost put to tender and in case bidder quote % rate in the BOQ, then tender shall be rejected.
- 1.11 The tender document can be downloaded from <http://eprocure.gov.in/eprocure/app> and be submitted only through the same website.

2. Registration of Bidder on e-Procurement Portal

- 2.1 Bidders are required to enroll on the e-Procurement module of the Central Public Procurement Portal ([URL:http://eprocure.gov.in/eprocure/app](http://eprocure.gov.in/eprocure/app)) by clicking on the link "Click here to Enroll". Enrolment on the CPP Portal is free of charge.
- 2.2 As part of the enrolment process, the bidders will be required to choose a unique username and assign a password for their accounts.
- 2.3 Bidders are advised to register their valid email address and mobile numbers as part of the registration process. These would be used for any communication from the CPP Portal.
- 2.4 Upon enrolment, the bidders will be required to register their valid Digital Signature Certificate (Class II or Class III Certificates with signing key usage) issued by any Certifying Authority recognized by CCA India (e.g. Sify/TCS/nCode/eMudhra etc.), with their profile.
- 2.5 Only one valid DSC should be registered by a bidder. Please note that the bidders are responsible to ensure that they do not lend their DSCs to others which may lead to misuse.
- 2.6 Bidder then logs into the site through the secured log-in by entering their user ID/password and the password of the DSC / eToken.
- 2.7 The CPP Portal also has user manual with detailed guidelines on enrolment and participation in the online bidding process. Any queries related to process of online bids or queries related to CPP Portal may be directed to the 24x7 CPP Portal Helpdesk.
- 2.8 The Institute will not be responsible for any type of technical issue regarding uploading of tender on website. [URL:http://eprocure.gov.in/eprocure/app](http://eprocure.gov.in/eprocure/app)) and any queries relating to the process of online bid submission or queries relating to CPP Portal in general may be directed to the 24x7 CPP Portal Helpdesk. The contact number for the helpdesk is **0120-4200462, 0120-4001002, and 91-8826246593.**

3. SEARCHING FOR TENDER DOCUMENTS

- 3.1 There are various search options built in the CPP Portal, to facilitate bidders to search active tenders by several parameters. These parameters could include Tender ID, organization name, location, date, value, etc. There is also an option of advanced search for tenders, wherein the bidders may combine a number of search parameters such as organization name, form of contract, location, date, other keywords etc. to search for a tender published on the CPP Portal.
- 3.2 Once the bidders have selected the tenders they are interested in, they may download the required documents / tender schedules. These tenders can be moved to the respective 'My Tenders' folder. This would enable the CPP Portal to intimate the bidders through SMS / e-mail in case there is any corrigendum issued to the tender document.
- 3.3 The bidder should make a note of the unique Tender ID assigned to each tender, in case they want to obtain any clarification / help from the Helpdesk.

4. PREPARATION OF BIDS

- 4.1 Bidder should take into account any corrigendum published on the tender document before submitting their bids.
- 4.2 Please go through the tender advertisement and the tender document carefully to understand the documents required to be submitted as part of the bid. Please note the number of covers in which the bid documents have to be submitted, the number of documents - including the names and content of each of the document that need to be submitted. Any deviations from these may lead to rejection of the bid.
- 4.3 Bidder, in advance, should get ready the bid documents to be submitted as indicated in the tender document / schedule and generally, they can be in PDF / XLS formats. Bid documents may be scanned with 100 dpi with black and white option.
- 4.4 To avoid the time and effort required in uploading the same set of standard documents which are required to be submitted as a part of every bid, a provision of uploading such standard documents (e.g. PAN card copy, annual reports, auditor certificates etc.) has been provided to the bidders. Bidders can use "My Space" area available to them to upload such documents. These documents may be directly submitted from the "My Space" area while submitting a bid, and need not be uploaded again and again. This will lead to a reduction in the time required for bid submission process.

5. SUBMISSION OF BIDS

- 5.1 Bidder should log into the site well in advance for bid submission so that he/she upload the bid in time i.e. on or before the bid submission time. Bidder will be responsible for any delay due to other issues.
- 5.2 The bidder has to digitally sign and upload the required bid documents one by one as indicated in the tender document.
- 5.3 A standard BOQ format has been provided with the tender document to be filled by all the bidders. Bidders are requested to note that they should necessarily submit their financial bids

in the format provided and no other format is acceptable. Bidders are required to download the BOQ file, open it and complete the white colored (unprotected) cells with their respective financial quotes and other details (such as name of the bidder). No other cells should be changed. Once the details have been completed, the bidder should save it and submit it online, without changing the filename. If the BOQ file is found to be modified by the bidder, the bid will be rejected.

- 5.4 The server time (which is displayed on the bidders' dashboard) will be considered as the standard time for referencing the deadlines for submission of the bids by the bidders, opening of bids etc. The bidders should follow this time during bid submission.
- 5.5 The uploaded tender documents become readable only after the tender opening by the authorized bid openers.
- 5.6 Upon the successful and timely submission of bids, the portal will give a successful bid submission message & a bid summary will be displayed with the bid no. and the date & time of submission of the bid with all other relevant details.
- 5.7 Kindly add scanned PDF or JPG format files of all relevant documents in a single PDF file of compliance sheet.

6 ASSISTANCE TO BIDDERS

- 6.1 Any queries relating to the tender document and the terms and conditions contained therein should be addressed to the Tender Inviting Authority for a tender or the relevant contact person indicated in the tender.
- 6.2 Any queries relating to the process of online bid submission or queries relating to CPP Portal in general maybe directed to the 24x7 CPP Portal Helpdesk. The contact number for the helpdesk is **0120-4200462, 0120-4001002, 91-8826246593, 0120-4001 005, 0120-6277 787**

For any technical related queries please call at 24 x 7
Help Desk Number 0120-4001 062 0120-4001 002 0120-4001 005 0120-6277 787
International Bidders are requested to prefix +91 as country code



INDIAN INSTITUTE OF SCIENCE EDUCATION AND RESEARCH (IISER) THIRUVANANTHAPURAM

SECTION I -NOTICE INVITING e-TENDERING

Indian Institute of Science Education and Research, THIRUVANANTHAPURAM invites online ITEM rate bids in open bid system from registered contractors/ agencies, found eligible as per the minimum requirements defined in clause 1 & 2 of NIT for the work mentioned below:

Name of work & Location: Landscaping works under Phase-1 for IISER TVM campus, Thiruvananthapuram

NIT NUMBER: IISER-T/1401-2/17/2019-20 dated: 23-10-2019

Approx. Estimated cost : **Rs. 20,85,684/-**

Period of completion : 2 months.

Cost of tender documents : **Rs. 560** (Rupees Five hundred and Sixty including GST) –(Non – Refundable)

Last Dates & time to fill/upload the tender through e-tendering : 31-10-2019 up to 16.00 hrs

Time & date of opening of Technical and financial bids : 01-11-2019 at 16.00 hrs

1. The applicant should be registered in appropriate class with CPWD, State PWD, Railways, MES, Govt. departments (Any One) / accredited agencies in Civil Works category. The bidder registration certificate should be valid till the last date of receipt of tender. The contractors shall have to fulfill the eligibility criteria of satisfactory execution of works as given below:
 - a) Three similar works, each of value not less than 40% of the estimated cost put to tender or
 - b) Two similar works, each of value not less than 60% of the estimated cost or
 - c) One similar works, each of value not less than 80% of the estimated cost. All amounts rounded off to a convenient full figure, in the last 5 years ending on the last day of the month previous to the one in which tenders are invited.
2. The agency shall have valid GST/PAN/TAN/ESIC/PF numbers/certificates.
3. The time allowed for carrying out the work will be **2 months** from the date of start as defined in schedule 'C' or from the first date of handing over of the site, whichever is later, in accordance with the phasing, if any, indicated in the tender. The bid document is two stage two Envelope e-tendering system can be seen from the Central Public Procurement Portal ([URL:https://eprocure.gov.in/eprocure/app](https://eprocure.gov.in/eprocure/app)) & Institute website www.iisertvm.ac.in. The contents of Envelope I & Envelope II are specified in the NIT.

4. Submission of Bid Documents

Information and instruction for bidder for e-tendering forming part of bid document and posted on website [URL:https://eprocure.gov.in/eprocure/app](https://eprocure.gov.in/eprocure/app). Last date and time of submission of bid, original EMD and deposition of original EMD and list of documents as detailed below at IISER THIRUVANANTHAPURAM and uploading the scan copies of the below mentioned documents:

List of Document to be scanned and uploaded within the period of bid submission:

- I. Transaction Receipt of online deposit of tender fee and EMD.
 - II. Proof of experience (work completion report), Contractor license.
 - III. Enlistment Order of the Contractor (Attested copy).
 - IV. Certificate of Registration for GST and acknowledgement of up to date filed return if required.
 - V. PAN
 - VI. Signed copy of Vol-I of tender documents.
5. Tender documents should be submitted online complete in all respect along with requisite amount of tender fee (cost of bid document). Complete set of tender documents comprising Volume I, and financial bids has been made available at e-tender portal <http://www.eprocurement & www.iisertvm.ac.in>
6. Director, Indian Institute of Science Education & Research, Thiruvananthapuram shall be the "Accepting Authority" hereinafter referred to as such for the purpose of this Contract.
7. Bids must be accompanied by tender fee and bid-security/EMD (Earnest Money Deposit) amount specified for the work in clause 10 payable at THIRUVANANTHAPURAM and drawn in favour of The Director; IISER THIRUVANANTHAPURAM Bid Security shall have to be valid for 90 days beyond the validity of the bid.
8. **Bid Security/EMD and Tender fee.**

9.1 Bid Security/EMD amounting to **Rs. 41,714/-** and tender fee of **Rs. 560/-** (Including 12% GST charges) shall be deposited in IISER THIRUVANANTHAPURAM Bank account through State Bank Collect as detailed below failing which the bid will be declared non responsive. Bidder shall submit GST number along with payment receipt.

9.2 **Payment through SBI Collect as detailed below:**
<https://www.onlinesbi.com/sbicollect/icollecthome.htm> -> Accept Terms & Conditions then Click Proceed -> Select State- Kerala & Select Type of Corporate / Institution – Educational Institute -> Select Educational Institutions Name- IISER THIRUVANANTHAPURAM-> Select Payment Category – Works-Civil/Electrical -> Provide the details of payment along with the bank details of the bidder & proceed for payment page.

9.3 The required E.M.D and tender cost (nonrefundable) in the shape of demand draft in favour of "IISER THIRUVANANTHAPURAM" shall be deposited physically through speed post/registered post/courier in a sealed envelope, addressed to "The Superintending Engineer, IISER Campus, Near Jersey Farm, Maruthamala P.O, Vithura, Pin: 695551" super-scribing the "NIT No. along with Name of work" on the top of the envelope and should reach to the institute on or before **31/10/2019 at 16.00 hrs**. Demand Draft received after the last date of submission (**31/10/2019**) will not be acceptable and the bidder shall

be summarily rejected from tender. IISER TVM will not be responsible for any delay/loss during postal transit

- 9.4 A part of earnest money is acceptable in the form of bank guarantee also. In such case, 50% of earnest money or Rs.20 lakh, whichever is less, will have to be deposited in shape prescribed above and balance in shape of irrevocable Bank Guarantee from a Scheduled Bank and shall be valid 120 days from the last date of receipt of bid as per standard proforma attached.
- 9.5 Scanned copy of the net banking transaction receipt towards payment of tender fee shall be uploaded on the e-tendering website within the period of bid submission failing which the bid will be declared non responsive.
- 9.6 Bid Security/EMD of unsuccessful Bidders will be returned to them within 90 days from the date of acceptance of bid of the successful Bidder.
- 9.7 The Bid Security/EMD may be forfeited, if
- a) The bidder withdraws / modifies his Bid or any item thereof after opening of bid.
 - b) The successful Bidder fails within the specified time limit to commence the work.
9. Bid shall be opened on the day fixed for opening of bids at **16.00** hours, in the presence of the Bidders who wish to attend. If the office happens to be closed on the date of receipt of the bids as specified, the bids will be received and opened on the next working day at the same time and venue.
10. Bidder's attention is also drawn to instruction of filling and submission of tender Attached herewith. You may forward your queries on tender documents and /or depute your technical representative for discussion on tender /drawings to clarify doubts, if any, at least two days before the date of submission mentioned in the website.
11. The Bidder may submit their questions/ queries/ clarifications if any, in writing or by email/ fax to reach the IISER THIRUVANANTHAPURAM at least two days before the date for bid submission. Bidders can send queries on their letter head referring tender on e-mail address **registrar@iisertvm.ac.in** at least five days before the start date and time of submission of the bids. Only relevant answers shall be answered and IISER THIRUVANANTHAPURAM shall not be responsible for delay in getting the answers.
12. If any amendment in the tender document uploaded on the website is necessitated due to any query raised by any bidder including the text of the questions raised (without identifying the source of enquiry) and the responses given will be uploaded as corrigendum on websites (URL:<https://eprocure.gov.in/eprocure/app>) and www.iisertvm.ac.in Bidders are requested to take note of the corrigendum and quote their rates accordingly. In case revised BOQ is uploaded on website by IISER, tenderer /bidder has to quote in revised BOQ only. The uploading quotation in pre-revised BOQ shall be considered as a willful negligence by the bidder and his quotation shall be considered as non-responsive.

13. Cost of Bidding

The Bidder shall bear all costs associated with the preparation and submission of his Bid, and the IISER THIRUVANANTHAPURAM will in no case be responsible and liable for these costs.

14. Site visit & availability of site.

- a) The Bidder should inform the IISER in advance about the proposed site visit.
- b) The Bidder, at his own responsibility and risk is encouraged to visit, inspect and Survey the Site and its surroundings and satisfy himself before submitting his Bid as to the form and nature of the Site, the means of access to the Site, the Accommodation he may require etc.
- c) In general, Bidders shall themselves obtain all necessary information as to risks, contingencies and other circumstances which may influence or affect their bid. A Bidder shall be deemed to have full knowledge of the Site, whether he inspects it or not and no extra claims due to any misunderstanding or otherwise shall be allowed.
- d) The costs of visiting the Site shall be at the Bidders' own expense. Any report shared at the site, by the IISER is subject to verification by the contractor. Any deviations of information in the report and the actual site will not be the responsibility of the IISER.
- e) The site for the work is available for visit from the date of issue of the tender.
- f) The architectural and structural drawings shall be made available in phased manner as per requirement of the same as per approved program of completion submitted by the contractor after award of the work.

15. Content of Bidding Documents

- a) Submission of a bid by a Bidder implies that he has read this notice and all other contract documents and has made himself aware of the scope and specifications of the work to be executed and local conditions and other factors having a bearing on the execution of the works.
- b) The Bidder shall submit the Bid, which satisfies each and every condition laid down in the Bid documents, failing which, the bid is liable to be rejected.
- c) Notice inviting e-Tender shall form part of the Contract document.
- d) The rate quoted in the price bid shall be inclusive of all taxes, freight charges etc. no extra shall be claimed.
- e) The documents listed below comprises one set of bid document that are issued to Bidders:

PART – I Envelope –I (Tender condition)

- a) Notice Inviting Tender (Including eligibility criteria)
- b) Tender Form and General Rules and Directions for the Guidance of the Contractor
- c) Format of BG
- d) Schedule C

PART-II Envelop II – (Financial bid)

Volume –III: Financial bid Schedule of Quantity (SOQ).

16. Amendment of Bid Documents

Before the deadline for submission of bids, the IISER THIRUVANANTHAPURAM may modify the bidding documents by issuing corrigendum. Any corrigendum so issued shall be part of the bid documents as well as Contract document and shall be on uploaded website [URL:https://eprocure.gov.in/eprocure/app](https://eprocure.gov.in/eprocure/app) and www.iisertvm.ac.in Bidders should take note of the uploaded corrigendum and submit the tenders accordingly.

17. Bid Validity

- a. The bid submitted shall become invalid if:
 - (i) The bidders is found ineligible.
 - (ii) The bidder does not deposit online tender fee and EMD with IISER THIRUVANANTHAPURAM before the date and time fixed for opening of the bids.
 - (iii) The bidders does not upload all the documents (including GST registration) as stipulated in the bid document.
 - (iv) If any discrepancy is noticed between the documents as uploaded at the time of submission of bid and hard copies as submitted physically by the lowest tenderer in the office of tender opening authority.
- b. The bids submitted shall remain valid for acceptance for a period of 90 days from the date of opening of the technical bids. If any bidder withdraws his tender before the said period or issue of letter of acceptance, whichever is earlier, or makes any modifications in the terms and conditions of the tender which are not acceptable to the IISER, THIRUVANANTHAPURAM, then the IISER, THIRUVANANTHAPURAM shall, without prejudice to any other right or remedy, be at liberty to forfeit 50% of the said earnest money as aforesaid. Further the bidder shall not be allowed to participate in the any tendering process of IISER TVM for a period of 3 years.

18. Bid Opening

- a) Online bid documents submitted by intending bidders shall be opened only of those bidders, whose tender fee and EMD is deposited online with IISER THIRUVANANTHAPURAM and scanned their scanned copies i/c tender documents scanned and uploaded are found in order. On the due date and appointed time IISER, THIRUVANANTHAPURAM will first open Envelope – I of bid. Bidders satisfying conditions of 19(a), including amendment as per clause 17 if applicable, in the presence of the Bidders or their representatives who choose to attend In the event of the specified date for Bid opening being declared a holiday by the IISER, THIRUVANANTHAPURAM, and the Bids will be opened at the appointed time and location on the next working day.
- b) Financial bids of the bidders who have submitted unconditional Bids together with requisite Bid security and meeting the eligibility criteria as specified in the NIT shall opened in the presence of representatives of intending bidders on the date and time specified in the NIT for opening of the financial bid.

19. Clarification of Bids

- a) To assist in the examination and comparison of Bids, the IISER, THIRUVANANTHAPURAM may, at its discretion, ask any Bidder for clarification of his Bid, including breakdown of unit rates. The request for clarification and the response shall be in writing or by email / fax, but no change in the price or substance of the Bid shall be sought, offered, or permitted except as required to confirm the correction of arithmetic errors discovered by the IISER, THIRUVANANTHAPURAM in the evaluation of the bids.
- b) No, Bidder shall contact the IISER, THIRUVANANTHAPURAM on any matter relating to his bid from the time of the bid opening to the time the contract is awarded.
- c) Any effort by the Bidder to influence the IISER's bid evaluation, bid comparison or contract award decisions, may result in the rejection of his bid.
- d) Indian Institute of Science Education and Research THIRUVANANTHAPURAM, does not bind itself to accept the lowest or any other bid, and reserves the right to reject any or all of the tenders received without assigning any reasons. Bids in which any of the prescribed conditions are not fulfilled or any conditions including that of the conditional rebate put forth by the bidder shall be summarily rejected.
- e) If the Bid of the successful Bidder is seriously unbalanced in relation to the Engineer- in-charge or his representative's estimate of the cost of work to be executed under the contract, the IISER, THIRUVANANTHAPURAM may require the Bidder to produce detailed rate analyses for any or all items of the Bill of Quantities, to demonstrate the internal consistency of those rates with the implementation/construction methods and schedule proposed.

20. Award Criteria

- a) IISER THIRUVANANTHAPURAM reserves the right without being liable for any damages or obligation to inform the bidder to:
 - 20.a.1. Amend the scope and value of the contract to the bidder
 - 20.a.2. Reject any or all applications without assigning any reasons
 - b) IISER, THIRUVANANTHAPURAM shall award the contract to the Bidder whose evaluated offer / bid has been determined to be the technically suitable and financially lowest and is substantially responsive to the Bidding Document, provided further that the Bidder is determined to be qualified to execute the contract satisfactorily. The Board of Governors of IISER reserves the right to accept or reject any application and to annul the pre-qualification process and reject all applications at any time, without thereby incurring any liability to the affected applicants or specifying the grounds for the Employer's action
21. Contractor whose tender is accepted will be required to furnish Performance guarantee of 5% (Five Percent) of the tendered amount within the period specified in Schedule C. This guarantee shall be in accordance with the prescribed form. In case the contractor fails to deposit the said performance guarantee within the period as indicated in Schedule 'C' including the extended period if any, the Earnest Money deposited by the contractor shall be forfeited automatically without any notice to the contractor and without prejudice to any other right or remedy. The Earnest Money deposited along with tender shall be returned after receiving the aforesaid performance guarantee. The earnest money deposited along with bid shall be returned after receiving the aforesaid performance guarantee.
22. The contractor whose bid is accepted will also be required to furnish either copy of the applicable licenses/registrations or proof of applying for obtaining labour licenses, registration with EPFO, ESIC, and Provident Fund Code No. if applicable and also ensure the compliance of aforesaid provisions by the sub- contractors, if any engaged by the contractor for the said work and program chart (Time and Progress) within the period specified in Schedule C.
23. Bidder shall quote rates for all items in the BOQ of work in the financial bid document. It will be obligatory on the part of the tenderer to sign the tender document for all the components (The schedule of quantities, conditions and special conditions etc.)

24. Disclosures

Any change in the constitution of the contractor's firm, where it is a partnership firm, as declared in the prequalification documents submitted by the bidders at the time of submission of prequalification documents, should be disclosed to the IISER, THIRUVANANTHAPURAM, at any time between the submission of bids and the signing of the contract.

Handwritten signature and date: 28/10/19

**Superintending Engineer (Civil)
IISER TVM**

SECTION II

ADDITIONAL INFORMATION AND INSTRUCTION TO APPLICANTS

1.0. GENERAL

1.1 STATEMENT OF OBJECTIVES, BRIEF SCOPE & PARTICULARS OF THE WORK

The entire WORK **“Landscaping works under Phase-1 for IISER TVM campus, Thiruvananthapuram”** will be executed under a Single Point Responsibility system under composite contract system. In general scope of work shall be as per BOQ and includes **“Landscaping works under Phase-1 for IISER TVM campus, Thiruvananthapuram”** complete as per BOQ and architectural drawings.

- ❖ Work shall in general be executed as per, general conditions of the contract for CPWD Works 2014 with correction slips issued up to last date of submission of bids, particular Technical Specifications, CPWD Specifications, National Building code of India, relevant Indian Standard (IS) Codes, etc.
- ❖ After acceptance of the tender the lowest bidder should submit the general conditions of the contract as said above along with the contract agreement.
- ❖ As these buildings will have green building features, Contractors are expected to provide adequate and complete documentation, towards obtaining certification from GRIHA.
- ❖ Particulars given above are provisional and liable to change and must be considered only as advance information to assist the bidder.

1.2 Letter of transmittal and other forms for pre-qualification are attached (Annexure I)

1.3. All information called for in the enclosed forms should be furnished against the respective columns in the forms. If information is furnished in a separate document, reference to the same should be given against respective columns. Such separate documents shall be chronologically placed at the end of the prescribed application. If information is 'nil' it should also be mentioned as 'nil' or 'no such case'. If, any particulars/query is not applicable in case of the applicant, it should be stated as 'not applicable'. However, the applicants are cautioned that not giving complete information called for in the application forms required, not giving it in clear terms or making change in the prescribed forms or deliberately suppressing the information may result in the applicant being summarily disqualified. Applications made by Fax and those received late will not be entertained.

1.4. References, information and certificates from the respective clients certifying suitability, technical know-how or capability of the applicant should be signed by an officer not below the rank of Executive Engineer or equivalent.

1.5 The Tenderer is advised to attach any additional information which he thinks is necessary in regard to his capabilities to establish that the applicant is capable in all

respects to successfully complete the envisaged work. He is however, advised not to attach superfluous information. No further information will be entertained after pre-qualification document is submitted, unless it is called for by Employer.

- 1.6 The applicant may engage sub vendors for execution of Electrical, Lifts, and HVAC as mentioned below, or may execute the same on their own. In either case, the eligibility criteria given below shall be satisfied.

The applicant Principal Contractor shall associate (Association through MOU / Subsisting agreement) with contractors for Electrical/ HVAC /Fire Detection / Lifts who shall satisfy the eligibility criteria/ given below for each type of specialized Electrical Mechanical agency. For this purposes, the applicant principal contractor shall give at least 2 (Two) names for each category of associates. IISER will approve associates after verifying their credentials and experience. However, responsibility of getting the work done efficiently will rest with the Principal contractor. The consent letter from different associates shall also be enclosed along with tender.

The Principal contractor or Associates shall be required to possess valid license for respective trade for executing the specialized services.

- 1.7 LETTER OF TRANSMITTAL

The applicant should submit the letter of transmittal attached with tender document duly signed by the agency.

- 1.8 INTEGRITY AGREEMENT duly signed by the agency along with letter is required to be submitted by the agency.

LETTER OF TRANSMITTAL
(TO BE SUBMITTED IN COMPANY'S LETTER PAD)

From

To

THE DIRECTOR
INDIAN INSTITUTE OF SCIENCE EDUCATION & RESEARCH
(IISER) THIRUVANANTHAPURAM
Near Jersey Farm, Maruthamala P.O, Vithura, Pin: 695551, Trivandrum, Kerala, India

Sub: Submission of tender documents for the work of "Landscaping works under Phase-1 for IISER TVM campus, Thiruvananthapuram "

NIT NUMBER: IISER-T/1401-2/17/2019-20 dated: 23-10-2019

Having examined the details given in notification and the tender document for the above work, I/we hereby submit the tender documents and other relevant information. I/we agree with all the terms and conditions given in the bid document.

1. I/We hereby certify that all the statements made and information supplied in the enclosed forms and accompanying statements are true and correct.
2. I/We have furnished all information and details necessary for eligibility criteria and have no further pertinent information to supply.
3. I/We submit the requisite certified solvency certificate and authorize the Director, IISER, and THIRUVANANTHAPURAM to approach the Bank issuing the solvency certificate to confirm the correctness thereof. I/We also authorize Engineer In charge, THIRUVANANTHAPURAM to approach individuals, employers, firms and corporation to verify our competence and general reputation.
4. I/We submit the following certificates in support of our suitability, technical know-how & capability for having successfully completed the following works.

Name of Work:

Certificate from

- 1.
- 2.
- 3.

- 1.
- 2.
- 3.

Enclosures:

Seal of applicant
Date of submission

Signature(s) of applicant(s)

Undertaking to sign the integrity Agreement

To,

.....,
.....,
.....

Sub: SUBMISSION OF TENDER DOCUMENTS FOR THE WORK OF “

**Name of work & Location: Landscaping works under Phase-1 for IISER
TVM campus,Thiruvananthapuram**

NIT NUMBER: IISER-T/1401-2/17/2019-20 dated: 23-10-2019

Dear Sir,

It is hereby declared that IISER is committed to follow the principle of transparency, equity and competitiveness in public procurement.

The subject Notice Inviting Tender (NIT) is an invitation to offer made on the condition that the Bidder will sign the integrity Agreement, which is an integral part of tender/bid documents, failing which the tenderer/bidder will stand disqualified from the tendering process and the bid would be summarily rejected.

This declaration shall form part and parcel of the Integrity Agreement and signing of the same shall be deemed as acceptance and signing of the Integrity Agreement on behalf of the IISER.

Yours faithfully

Sd/-

Engineer in Charge

Forwarding letter for Integrity Agreement
(TO BE SUBMITTED IN COMPANY'S LETTER PAD)

To

INDIAN INSTITUTE OF SCIENCE EDUCATION & RESEARCH (IISER)

Near Jersey Farm, Maruthamala P.O,
Vithura, Pin: 695551,
Thiruvananthapuram, Kerala, India.

**Sub: SUBMISSION OF TENDER DOCUMENTS FOR THE WORK OF
“Landscaping works under Phase-1 for IISER TVM campus, Thiruvananthapuram”**

NIT NUMBER: IISER-T/1401-2/17/2019-20 dated: 23-10-2019

Dear Sir,

I/We acknowledge that IISER is committed to follow the principles thereof as enumerated in the Integrity Agreement enclosed with the tender/bid document.

I/We agree that the Notice Inviting Tender (NIT) is an invitation to offer made on the condition that I/We will sign the enclosed integrity Agreement, which is an integral part of tender documents, failing which I/We will stand disqualified from the tendering process. I/We acknowledge that THE MAKING OF THE BID SHALL BE REGARDED AS AN

UNCONDITIONAL AND ABSOLUTE ACCEPTANCE of this condition of the NIT.

I/We confirm acceptance and compliance with the Integrity Agreement in letter and spirit and further agree that execution of the said Integrity Agreement shall be separate and distinct from the main contract, which will come into existence when tender/bid is finally accepted by IISER. I/We acknowledge and accept the duration of the Integrity Agreement, which shall be in the line with Article 1 of the enclosed Integrity Agreement.

I/We acknowledge that in the event of my/our failure to sign and accept the Integrity Agreement, while submitting the tender/bid, IISER shall have unqualified, absolute and unfettered right to disqualify the tenderer/bidder and reject the tender/bids in accordance with terms and conditions of the tender/bid.

Yours faithfully

(Duly authorized signatory of the Bidder)

(To be signed by the bidder and the signatory competent / authorized to sign the relevant contract on behalf of IISER on Rs.200/- non judicial stamp paper)

INTEGRITY AGREEMENT

This Integrity Agreement is made at on this..... Day of. 20.....

BETWEEN

IISER represented through its Director, (Hereinafter referred as the 'Principal/Owner', which expression shall unless repugnant to the meaning or context hereof include its successors and permitted assigns)

AND

.....
(Name and Address of the Individual/firm/Company)

Through..... (Hereinafter referred to as the (Details of duly authorized signatory)

"Bidder/Contractor" and which expression shall unless repugnant to the meaning or context hereof include its successors and permitted assigns)

Preamble

WHEREAS the Principal / Owner has floated the Tender (NIT No.)
(hereinafter referred to as "Tender/Bid") and intends to award, under laid down organizational procedure, contract
for

.....
(Name of work)
hereinafter referred to as the "Contract".

ANDWHEREAS the Principal/Owner values full compliance with all relevant laws of the land, rules, regulations, economic use of resources and of fairness/transparency in its relation with its Bidder(s) and Contractor(s).

ANDWHEREAS to meet the purpose aforesaid both the parties have agreed to enter into this Integrity Agreement (hereinafter referred to as "Integrity Pact" or "Pact"), the terms and conditions of which shall also be read as integral part and parcel of the Tender/Bid documents and Contract between the parties.

NOW, THEREFORE, in consideration of mutual covenants contained in this Pact, the parties hereby agree as follows and this Pact witnesses as under:

Article 1: Commitment of the Principal/Owner

- 1) The Principal/Owner commits itself to take all measures necessary to prevent corruption and to observe the following principles:
 - (a) No employee of the Principal/Owner, personally or through any of his/her family members, will in connection with the Tender, or the execution of the Contract,

demand, take a promise for or accept, for self or third person, any material or immaterial benefit which the person is not legally entitled to.

- (b) The Principal/Owner will, during the Tender process, treat all Bidder(s) with equity and reason. The Principal/Owner will, in particular, before and during the Tender process, provide to all Bidder(s) the same information and will not provide to any Bidder(s) confidential / additional information through which the Bidder(s) could obtain an advantage in relation to the Tender process or the Contract execution.
 - (c) The Principal/Owner shall endeavor to exclude from the Tender process any person, whose conduct in the past has been of biased nature.
- 2) If the Principal/Owner obtains information on the conduct of any of its employees which is a criminal offence under the Indian Penal code (IPC)/Prevention of Corruption Act, 1988 (PC Act) or is in violation of the principles herein mentioned or if there be a substantive suspicion in this regard, the Principal/Owner will inform the Chief Vigilance Officer and in addition can also initiate disciplinary actions as per its internal laid down policies and procedures.

Article 2: Commitment of the Bidder(s)/Contractor(s)

- 1) It is required that each Bidder/Contractor (including their respective officers, employees and agents) adhere to the highest ethical standards, and report to the Government / Department all suspected acts of **fraud or corruption or Coercion or Collusion** of which it has knowledge or becomes aware, during the tendering process and throughout the negotiation or award of a contract.
- 2) The Bidder(s)/Contractor(s) commits himself to take all measures necessary to prevent corruption. He commits himself to observe the following principles during his participation in the Tender process and during the Contract execution:
 - a) The Bidder(s)/Contractor(s) will not, directly or through any other person or firm, offer, promise or give to any of the Principal/Owner's employees involved in the Tender process or execution of the Contract or to any third person any material or other benefit which he/she is not legally entitled to, in order to obtain in exchange any advantage of any kind whatsoever during the Tender process or during the execution of the Contract.
 - b) The Bidder(s)/Contractor(s) will not enter with other Bidder(s) into any undisclosed agreement or understanding, whether formal or informal. This applies in particular to prices, specifications, certifications, subsidiary contracts, submission or non-submission of bids or any other actions to restrict competitiveness or to cartelize in the bidding process.
 - c) The Bidder(s)/Contractor(s) will not commit any offence under the relevant IPC/PC Act. Further the Bidder(s)/Contractor(s) will not use improperly, (for the purpose of competition or personal gain), or pass on to others, any information or documents provided by the Principal/Owner as part of the business relationship, regarding plans, technical proposals and business details, including information contained or transmitted electronically.

- d) The Bidder(s)/Contractor(s) of foreign origin shall disclose the names and addresses of agents/representatives in India, if any. Similarly Bidder(s)/Contractor(s) of Indian Nationality shall disclose names and addresses of foreign agents/representatives, if any. Either the Indian agent on behalf of the foreign principal or the foreign principal directly could bid in a tender but not both. Further, in cases where an agent participates in a tender on behalf of one manufacturer, he shall not be allowed to quote on behalf of another manufacturer along with the first manufacturer in a subsequent/parallel tender for the same item.
 - e) The Bidder(s)/Contractor(s) will, when presenting his bid, disclose any and all payments he has made, is committed to or intends to make to agents, brokers or any other intermediaries in connection with the award of the Contract.
- 3) The Bidder(s)/Contractor(s) will not instigate third persons to commit offences outlined above or be an accessory to such offences.
 - 4) The Bidder(s)/Contractor(s) will not, directly or through any other person or firm indulge in fraudulent practice **means a willful misrepresentation or omission of facts or submission of fake/forged documents in order to induce public official to act in reliance thereof, with the purpose of obtaining unjust advantage by or causing damage to justified interest of others and/or to influence the procurement process to the detriment of the Government interests.**
 - 5) The Bidder(s)/Contractor(s) will not, directly or through any other person or firm use Coercive Practices (means the act of obtaining something, compelling an action or influencing a decision through intimidation, threat or the use of force directly or indirectly, where potential or actual injury may befall upon a person, his/her reputation or property to influence their participation in the tendering process).

Article 3: Consequences of Breach

Without prejudice to any rights that may be available to the Principal/Owner under law or the Contract or its established policies and laid down procedures, the Principal/Owner shall have the following rights in case of breach of this Integrity Pact by the Bidder(s)/Contractor(s) and the Bidder/ Contractor accepts and undertakes to respect and uphold the Principal/Owner's absolute right:

- 1) If the Bidder(s)/Contractor(s), either before award or during execution of Contract has committed a transgression through a violation of Article 2 above or in any other form, such as to put his reliability or credibility in question, the Principal/Owner after giving 14 days' notice to the contractor shall have powers to disqualify the Bidder(s)/Contractor(s) from the Tender process or terminate/determine the Contract, if already executed or exclude the Bidder/Contractor from future contract award processes. The imposition and duration of the exclusion will be determined by the severity of transgression and determined by the Principal/Owner. **Such exclusion may be forever or for a limited period as decided by the Principal/Owner.**

- 2) **Forfeiture of EMD/Performance Guarantee/Security Deposit:** If the Principal/Owner has disqualified the Bidder(s) from the Tender process prior to the award of the Contract or terminated/determined the Contract or has accrued the right to terminate/determine the Contract according to Article 3(1), the Principal/Owner apart from exercising any legal rights that may have accrued to the Principal/Owner, may in its considered opinion forfeit the entire amount of Earnest Money Deposit, Performance Guarantee and Security Deposit of the Bidder/Contractor.
- 3) **Criminal Liability:** If the Principal/Owner obtains knowledge of conduct of a Bidder or Contractor, or of an employee or a representative or an associate of a Bidder or Contractor which constitutes corruption within the meaning of IPC Act, or if the Principal/Owner has substantive suspicion in this regard, the Principal/Owner will inform the same to law enforcing agencies for further investigation.
- 4) **Article 4: Previous Transgression**
 - 1) The Bidder declares that no previous transgressions occurred in the last 5 years with any other Company in any country confirming to the anticorruption approach or with Central Government or State Government or any other Central/State Public Sector Enterprises in India that could justify his exclusion from the Tender process.
 - 2) If the Bidder makes incorrect statement on this subject, he can be disqualified from the Tender process or action can be taken for banning of business dealings/ holiday listing of the Bidder/Contractor as deemed fit by the Principal/ Owner.
 - 3) If the Bidder/Contractor can prove that he has resorted / recouped the damage caused by him and has installed a suitable corruption prevention system, the Principal/Owner may, at its own discretion, revoke the exclusion prematurely.

Article 5: Equal Treatment of all Bidders/Contractors/Subcontractors

- 1) The Bidder(s)/Contractor(s) undertake(s) to demand from all subcontractors a commitment in conformity with this Integrity Pact. The Bidder/Contractor shall be responsible for any violation(s) of the principles laid down in this agreement/Pact by any of its Subcontractors/ sub-vendors.
- 2) The Principal/Owner will enter into Pacts on identical terms as this one with all Bidders and Contractors.
- 3) The Principal/Owner will disqualify Bidders, who do not submit, the duly signed Pact between the Principal/Owner and the bidder, along with the Tender or violate its provisions at any stage of the Tender process, from the Tender process.

Article 6- Duration of the Pact

This Pact begins when both the parties have legally signed it. It expires for the Contractor/Vendor 12 months after the completion of work under the contract or till the continuation of defect liability period, whichever is more and for all other bidders, till the Contract has been awarded.

If any claim is made/lodged during the time, the same shall be binding and continue to be valid despite the lapse of this Pacts as specified above, unless it is discharged/determined by the Competent Authority.

Article 7- Other Provisions

- 1) This Pact is subject to Indian Law, place of performance and jurisdiction is the **Headquarters of the** Principal/Owner, who has floated the Tender.
- 2) Changesandsupplementsneedtobemadeinwriting.Sideagreementshavenotbeenmade.
- 3) If the Contractor is a partnership or a consortium, this Pact must be signed by all the partners or by one or more partner holding power of attorney signed by all partners and consortium members. In case of a Company, the Pact must be signed by a representative duly authorized by board resolution.
- 4) Should one or several provisions of this Pact turn out to be invalid; the remainder of this Pact remains valid. In this case, the parties will strive to come to an agreement to their original intensions.
- 5) Itisagreedtermandconditionthatanydisputeordifferencearisingbetweenthepartieswith regard to the terms of this Integrity Agreement / Pact, any action taken by the Owner/Principal in accordance with this **Integrity Agreement/ Pact or interpretation thereof shall not be subject to arbitration.**

Article 8- LEGAL AND PRIOR RIGHTS

All rights and remedies of the parties hereto shall be in addition to all the other legal rights and remedies belonging to such parties under the Contract and/or law and the same shall be deemed to be cumulative and not alternative to such legal rights and remedies aforesaid. For the sake of brevity, both the Parties agree that this Integrity Pact will have precedence over the Tender/Contact documents with regard any of the provisions covered under this Integrity Pact.

IN WITNESS WHEREOF the parties have signed and executed this Integrity Pact at the place and date first above mentioned in the presence of following witnesses:

.....
(For and on behalf of Principal/Owner)

.....
(For and on behalf of Bidder/Contractor)

WITNESSES: 1.....
(Signature, name and address) 2.
(Signature, name and address) Place:

Dated:

CHECKLIST: Details of Enclosures/documents required to be uploaded on website <https://eprocure.gov.in/eprocure/app> through the E-procurement portal up to the last date and time of submission of tender.

S.N.	Description of item	Scanned copies Uploaded on website	Not uploaded
1.	Eligibility documents- Empanelment/Registration certificate		
2.	Power of attorney as required		
3.	Certificate of Registration as required		
4.	Memorandum of Articles of association as required		
5.	C A certificate for Audited Balance Sheet and Profit & Loss statement for the past five financial years		
6.	Consent letter from associates if Electro-Mechanical services are proposed to be done through Associates, under reference to Para 1.6 A to D under Section-II. Information and Instructions to applicants	NA	NA
7.	Supporting certificates for technical and financial capability from relevant authorities.		
8	Organization Chart with responsibilities, Curriculum Vitae of personnel proposed for this project.		
9	INTEGRITY AGREEMENT duly signed by the agency on stamp paper along with letter of Transmittal		
10	Any other important information.		
11	Scan copies of net banking receipt towards payment of Tender fee		
12	Letter of transmittal duly signed by the bidder.		
13	Uploading of the tender document Vol-I, Vol-II and Vol-III financial bids		
14	Any other relevant document required to be uploaded on website as per tender conditions.		

Note: - All documents should be arranged as Per S.N. while submitting and mentioned S.N. on right most top corner.



**INDIAN INSTITUTE OF SCIENCE EDUCATION AND RESEARCH
IISER THIRUVANANTHAPURAM**

**Name of work & Location: Landscaping works under Phase-1 for IISER
TVM campus, Thiruvananthapuram**

NIT NUMBER: IISER-T/1401-2/17/2019-20 dated: 23-10-2019

SECTION – II

ITEM RATE & CONTRACT FOR WORKS

SECTION- II

Tender Form

ITEM Rate Tender & Contract for Works

Name of work & Location: Landscaping works under Phase-1 for IISER TVM campus, Thiruvananthapuram

NIT NUMBER: IISER-T/1401-2/17/2019-20 dated: 23-10-2019

- (a). Tender(s) to be submitted online by (time) **16.00 hours on 31.10.2019**
(URL:<https://eprocure.gov.in/eprocure/app>)

- (b). Tender(s) to be opened in presence of tenderers who may be present at **16.00 hours on 01-11-2019** in the office of the Superintending Engineer(Civil), Indian Institute of Science Education and Research, THIRUVANANTHAPURAM

TENDER

I/We have read and examined the notice Inviting Tender, Schedule, Specifications applicable, Drawings & Designs, General Rules and Directions, Conditions of Contract, clauses of contract, special conditions & other document and Rules referred to in the conditions of contract and all other contents in the tender document for the work.

I/We hereby tender for the execution of the work specified for the Director Of Indian Institute of Science Education and Research THIRUVANANTHAPURAM (IISER-THIRUVANANTHAPURAM) within the time specified in Schedule **2 months viz**, schedule of quantities and in accordance in all respects with the specifications, designs, drawings and instructions in writing referred to the Conditions of contract and with such materials as are provided for and in respects in accordance with such conditions so far as applicable.

We agree to keep the tender valid for (90) ninety days from the due date of its opening and not to make any modifications in its terms and conditions.

A sum of Rs (figure) -----(in words) -----

has been deposited in Deposit at call Receipt of a Schedule bank/demand draft of a scheduled bank/bank guarantee issued by a Schedule Bank as earnest money. If I/we, fail to furnish the prescribed performance guarantee within prescribed period, I/we agree that the said Director Of Indian Institute of Science Education and Research THIRUVANANTHAPURAM (IISER-THIRUVANANTHAPURAM) or his successors in offices shall without prejudice to any other right or remedy, be at liberty to forfeit the said earnest money absolutely, if I/we fail to commence work as specified, I/we agree that Director of Indian Institute of Science Education and Research

THIRUVANANTHAPURAM (IISER-THIRUVANANTHAPURAM) or his successors in office shall without prejudice to any other right or remedy available in law, be at liberty to forfeit the said earnest money and the performance guarantee absolutely.

The said Performance Guarantee shall be a guarantee to execute all the works referred to in the tender documents upon the terms and conditions contained or referred to those in excess of that limit at the rates to be determined in accordance with the provision contained in Clause and 12.3 of the tender form. Further, I/We agree that in case of forfeiture of Earnest Money or Performance Guarantee as aforesaid, I/We shall be debarred for participation in the re-tendering process of the work.

I/We hereby declare that I/we shall treat the tender documents drawings and other records connected with the work as secret/ confidential documents and shall not communicate information / derived there from to any person other than a person to whom I/We am/are authorized to communicate the same or use the information in any manner prejudicial to the safety of the state or IISER THIRUVANANTHAPURAM.

Dated

Signature of Contractor Seal

Postal Address

Witness: Address: Occupation:

ACCEPTANCE

The above tender (as modified by you as provided in the letters mentioned hereunder) is accepted by me for and on the Director IISER, THIRUVANANTHAPURAM for sum of Rs.....(Rupees.....
.....
.....).

The letters referred to below shall form part of this contract Agreement:-

- (a)

- (b)

- (c)

For & on behalf of the Director, IISER
THIRUVANANTHAPURAM

Signature.....

Dated.....

Designation.....

Appendix 'I'

**Form of Earnest Money Deposit
Bank Guarantee Bond**

WHEREAS, contractor..... (Name of contractor) (hereinafter called "the contractor") has submitted his tender dated (date) for the construction of (name of work) (hereinafter called "the Tender")

KNOW ALL PEOPLE by these presents that we (name of bank) having our registered office at (hereinafter called "the Bank") are bound unto (Name and division of Executive Engineer) (hereinafter called "the Engineer-in-Charge") in the sum of Rs. (Rs. in words) for which payment well and truly to be made to the said Engineer-in- Charge the Bank binds itself, his successors and assigns by these presents.

SEALED with the Common Seal of the said Bank this day of 20... . THE CONDITIONS of this obligation are:

- (1) If after tender opening the Contractor withdraws, his tender during the period of validity of tender (including extended validity of tender) specified in the Form of Tender;
- (2) If the contractor having been notified of the acceptance of his tender by the Engineer-in-Charge:
 - (a) fails or refuses to execute the Form of Agreement in accordance with the Instructions to contractor, if required;
 - OR
 - (b) fails or refuses to furnish the Performance Guarantee, in accordance with the provisions of tender document and Instructions to contractor,

We undertake to pay to the Engineer-in-Charge either up to the above amount or part thereof upon receipt of his first written demand, without the Engineer-in-Charge having to substantiate his demand, provided that in his demand the Engineer-in-Charge will note that the amount claimed by him is due to him owing to the occurrence of one or any of the above conditions, specifying the occurred condition or conditions.

This Guarantee will remain in force up to and including the date* after the deadline for submission of tender as such deadline is stated in the Instructions to contractor or as it may be extended by the Engineer-in- Charge, notice of which extension(s) to the Bank is hereby waived. Any demand in respect of this Guarantee should reach the Bank not later than the above date.

DATE

SIGNATURE OF THE BANK

WITNESS
(SIGNATURE, NAME AND ADDRESS)

SEAL

*Date to be worked out on the basis of validity period of 6 months from last date of receipt of ten

Appendix 'II'

Form of Performance Security (Guarantee)

Bank Guarantee Bond

1. In consideration of the Director IISER THIRUVANANTHAPURAM (hereinafter called "IISER-THIRUVANANTHAPURAM") having offered to accept the terms and conditions of the proposed agreement between-----
-----and----- (hereinafter called "the said Contractor(s)") for the work -----
------(hereinafter called "the said agreement") having agreed to production of an irrevocable Bank Guarantee for Rs.----- (Rupees -----
-----only) as a security/guarantee from the contractor(s) for compliance of his obligations in accordance with the terms and conditions in the said agreement.

We ----- (hereinafter referred to as "the Bank") hereby (indicate the name of the Bank) Undertake to pay to the IISER THIRUVANANTHAPURAM an amount not exceeding Rs----- (Rupees -----only) on demand by IISER THIRUVANANTHAPURAM

2. We -----do hereby undertake to pay the amounts due and payable (indicate the name of the Bank) under this Guarantee without any demure, merely on demand from the IISER THIRUVANANTHAPURAM stating that the amount claimed as required to meet the recoveries due or likely to be due from the said contractor(s). Any such demand made on the bank shall be conclusive as regards the amount due and payable by the bank under this Guarantee. However, our liability under this guarantee shall be restricted to an amount not exceeding Rs----- (Rupees-----
-----only)

3. We, the said bank further undertake to pay the IISER THIRUVANANTHAPURAM any money so demanded notwithstanding any dispute or disputes raised by the contractor(s) in any suit or proceeding pending before any court or Tribunal relating thereto, our liability under this present being absolute and unequivocal.

The payment so made by us under this bond shall be a valid discharge of our liability for payment there under and the Contractor(s) shall have no claim against us for making such payment.

4. We, ----- further agree that the guarantee herein contained shall (indicate the name of the Bank) remain in full force and effect during the period that would be taken for the performance of the said agreement and that it shall continue to be enforceable till all the dues of the IISER THIRUVANANTHAPURAM under or by virtue of the said agreement have been fully paid and its claims satisfied or discharged or till Engineer-in-Charge on behalf of the IISER THIRUVANANTHAPURAM certified that the terms and conditions of the said agreement have been fully and properly carried out by the said Contractor(s) and accordingly discharge this guarantee.

5. We, ----- further agree with the IISER THIRUVANANTHAPURAM that the IISER THIRUVANANTHAPURAM (indicate the name of the Bank) shall have the

fullest liberty without our consent and without affecting in any manner our obligation hereunder to vary any of the terms and conditions of the said agreement or to extend time of performance by the said Contractor(s) from time to time or to postpone for any time or from time to time any of the powers exercisable by the

IISER THIRUVANANTHAPURAM against the said contractor(s) and to forbear or enforce any of the terms and conditions relating to the said agreement and we shall not be relieved from our liability by reason of any such variation or extension being granted to the said Contractor(s) or for any forbearance, act of omission on the part of the IISER THIRUVANANTHAPURAM or any indulgence by the IISER THIRUVANANTHAPURAM to the said Contractor(s) or by any such matter or thing whatsoever which under the law relating to sureties would, but for this provision, have effect of so relieving us.

6. This guarantee will not be discharged due to the change in the constitution of the Bank or the Contractor(s).
7. We, ----- lastly undertake not to revoke this guarantee except (indicate the name of the Bank) with the previous consent of the IISER THIRUVANANTHAPURAM in writing.
8. This guarantee shall be valid up to-----unless extended on demand by the IISER THIRUVANANTHAPURAM. Notwithstanding anything mentioned above, our liability against this guarantee is restricted to Rs----- (Rupees-----only) and unless a claim in writing is lodged with us within six months of the date of expiry or the extended date of expiry of this guarantee all our liabilities under this guarantee shall stand discharged.

Dated the -----day of-----for----- (indicate the name of the Bank)

Appendix 'III'

Proforma of Agreement

ARTICLE OF AGREEMENT is made at THIRUVANANTHAPURAM on the day of..... 2017 between Indian Institutes Of Science Education and Research THIRUVANANTHAPURAM, (IISER THIRUVANANTHAPURAM) (Herein after referred to as the employer which expression shall include its successors and assigns where the context so admits) of the one part and -----

(Hereinafter referred to as the "contractor(s) which expression shall include his/their respective heirs, executors, administrators and assigns where the context so admits) of the other part.

WHEREAS the employer is desirous of getting the work.....
.....don eandcauseddrawings, scheduleof quantities, termsandconditionsand specificationdescribing the work to be executed and completed maintained.(hereinafter called "the works")and has accepted a tender of the CONTRACTOR for the execution, completion and guarantee of such works.

ANDWHEREAS the contractor has deposited a Sum of Rs.-----

----- With employer as security for the due performance of this agreement as provided in the said Conditions.

NOW IT IS HEREBY agreed and declared by and between the parties as follows.

- (a) In consideration of the payments to be made to him as herein after provided the contractor shall upon and subject to the condition herein contained and the said conditions executed and complete the work shown upon the said drawings and such further detailed drawings which may be furnished to him and described in the said specifications and the said priced schedule of quantities within ----- from the date of order to commence the work.
- (b) The employer shall pay to the contractor such sum that shall become payable hereunder at the times and in the manner specified in the said conditions.
- (c) Time is essence of this agreement and the contractor agrees to pay compensation for delay as per Clause 2 of general Condition of Contract.
- (e) The documents mentioned below under (g) shall form the basis of this agreement and the decision Engineer or the Engineers in Charge, in reference to all matters of dispute as to material and workmanship shall be final and binding on both the parties.
- (f) The employer through the Engineer-in-Charge reserves to himself the right of altering the drawings and the adding to or omitting any items of works or of having portions of the same carried out departmentally or otherwise and such alterations or variations shall not violate agreement.

- (g) This agreement comprises the work said above and the entire subsidiary work connected there with, even though work may not be shown on the drawings or described in the said specifications or the priced schedule of quantities.

This agreement contains the following documents in addition to pages of articles of agreement.

- (a) NIT/WORK ORDER
- (b) Item rate tender form & contract for works.
- (c) General Rules and Directions
- (d) Condition of contracts
- (e) Clauses of contracts
- (f) Safety code
- (g) Models rules for the protection of health, sanitary arrangements for workers employed by IISER THIRUVANANTHAPURAM or its Contractors.
- (h) Contractors labour regulations
- (i) Proforma of agreement
- (j) Proforma of Schedule A to C
- (k) Special Condition of contracts
- (l) Technical specifications
- (m) Tenders drawings
- (n) Price Schedule/ Schedule of Quantities
- (o) All corresponds between the parties until award of contract.
- (p) Prequalification document

In witness whereof the parties hereto have their respective hands the day and the year herein above written.

Signed by for and on behalf of the
employer. Engineer In Charge

Witness (1)-----

Witness (2)-----

Signed by the said contractor

Address-----

Witness (1)-----

Countersigned

Witness (2)-----

Appendix 'IV'

PROFORMA BANK GUARANTEE IN LIEU OF BID SECURITY

**(On Non Judicial Stamp paper to be stamped in accordance
with stamp act, the stamp paper to be in name of
Executing Bank)**

Ref.....

Date.....

Bank GuaranteeNo.....

To **INDIANINSTITUTE OF SCIENCE EDUCATION & RESEARCH, THIRUVANANTHAPURAM**

Dear Sir,

In accordance with your Notice Inviting Tender for _____ under your tender
No _____ dated _____ M/s _____ (hereinafter called the
Tenderer) with following directors on their Board of Directors /Partners of the firm.

1 _____	2 _____
3 _____	4 _____
5 _____	6 _____
7 _____	8 _____
9 _____	10 _____

Wish to participate in the said tender for the following:

1 _____
2 _____
3 _____

Whereas it is a condition in the tender documents that the tenderer has to deposit Bid Security with respect to the tender, with Indian Institute of Science Education & Research, THIRUVANANTHAPURAM amounting to Rs..... or alternatively the tenderer is required to submit "Bank Guarantee" from a nationalized bank irrevocable and operative till 28 days after the validity of the offer. (i.e. 120 days from the last date of receipt of bid), for the like amount which amount is likely to be forfeited on the happening of contingencies mentioned in the tender documents. And whereas the tenderer desires to secure exemption from deposit of Bid Security and has offered to furnish a Bank Guarantee for a sum of Rs..... to the IISER, THIRUVANANTHAPURAM for the purpose of securing exemption from the deposit of Bid Security.

1. NOW THEREFORE, we the Bank, a body corporate constituted under the Banking Companies (Acquisition and Transfer of undertakings) Act 1969 and having a branch office at..... (hereinafter referred to as the Bank") do hereby undertake and agree to pay on demand in writing by the IISER, THIRUVANANTHAPURAM the amount of Rs..... (Rupees.....) to the **Indian Institute of Science Education & Research, THIRUVANANTHAPURAM** without any demur, reservation or recourse.
2. We, the aforesaid Bank, further agree that the IISER, THIRUVANANTHAPURAM shall be the sole judge of and as to whether the tenderer has committed any breach or breaches of any of the terms and conditions of the tender and the extent of loss, damage, costs, charges and expenses caused to or suffered by or that may be caused to or suffered by the IISER, THIRUVANANTHAPURAM on account thereof the extent of the bid security required to be deposited by the Tenderer in respect of the said Tender document and the decision of the IISER, THIRUVANANTHAPURAM that the Tenderer has committed such breach or breaches and as to the amount or amounts of loss, damage, costs, charges and expenses caused to or suffered by or that may be caused to or suffered by the IISER, THIRUVANANTHAPURAM shall be final and binding on us.
3. We, the said Bank further agree that the Guarantee herein contained shall remain in full force and effect until it is released by the IISER, THIRUVANANTHAPURAM and change in the constitution, liquidation or dissolution of the Tenderer shall not discharge our liability guaranteed herein.
4. It is further declared that it shall not be necessary for the IISER, THIRUVANANTHAPURAM to proceed against the Contractor before proceeding against the Bank and the Guarantee herein contained shall be enforceable against the Bank notwithstanding any security which the IISER, THIRUVANANTHAPURAM may have obtained or shall obtain from the Contractor at the time when proceedings are taken against the Bank for whatever amount may be outstanding or unrealized under the Guarantee.
5. The right of the IISER, THIRUVANANTHAPURAM to recover the said amount of Rs..... (Rupees) from us in manner aforesaid will not be affected or suspended by reason of the fact that any dispute or disputes have been raised by the said

M/s..... (Tenderer) and/or that any dispute or disputes are pending before any authority, officer, tribunal or arbitrator(s) etc. Notwithstanding anything stated above, our liability under this guarantee shall be restricted to Rs.....(Rupees.....) and our guarantee shall remain in force up to..... and unless a demand or claim under the guarantee is made on us in writing within three months after the aforesaid date i.e. on or before the all your rights under the guarantee shall be forfeited and we shall be relieved and discharged from all liabilities there under.

Date.....

place.....

(Signature)_____

(Printed Name)_____

(Designation)_____

(Bank's Common seal)_____

(Authorisation No.)_____

In the presence of:

Witness

1)_____

2)_____

Accepted

(Signature of the Officer)

For and on behalf of the

INDIAN INSTITUTE OF SCIENCE
EDUCATION AND RESEARCH,
THIRUVANANTHAPURAM

APPENDIX (IV) -CLAUSE 25

Notice for appointment of Arbitrator [Refer Clause 25 of General Conditions of Contract]

To
The Director
IISER THIRUVANANTHAPURAM.

Dear Sir,

In terms of clause 25 of the agreement, particulars of which are given below, I/we hereby give notice to you to appoint an arbitrator for settlement of disputes mentioned below:

1. Name of applicant
2. Whether applicant is Individual/Prop. Firm/Partnership Firm/Ltd. Co.
3. Full address of the applicant
4. Name of the work and contract number in which arbitration sought
5. Name of the Division which entered into contract
6. Contract amount in the work
7. Date of contract
8. Date of contract Date of initiation of work
9. Stipulated date of completion of work
10. Actual date of completion of work (if completed)
11. Total number of claims made
12. Total amount claimed
13. Date of intimation of final bill (if work is completed)
14. Date of payment of final bill (if work is completed)
15. Amount of final bill (if work is completed)
16. Date of request made to SE for decision
17. Date of receipt of SE's decision
18. Date of appeal to you
19. Date of receipt of your decision.

Specimen signatures of the applicant

(only the person/authority who signed the contract should sign)

I/We certify that the information given above is true to the best of my/our knowledge. I/We enclose following documents.

1. Statement of claims with amount of claims.
- 2.

Yours faithfully

Copy in duplicate to:
Engineer in Charge.

PROFORMA OF SCHEDULES

(Operative Schedules to be supplied to each intending tenderer)

SCHEDULE 'A'

Schedule of quantities

Enclosed as Financial bid document

SCHEDULE 'B'

Schedule of materials to be issued to the contractor.

S.No	Description of item	Quantity	Rates in figures & words at which the material will be charged to the contractor	Place of issue
1	2	3	4	5
	NIL			

Tools and plants to be hired to the contractor

S.No	Description	Hire charges per day	Place of issue
1	2	3	4
	NIL		

Extra schedule for specific requirements/document for the work, if any. -- NIL—

Reference to General Conditions of contract.-

Name of work & Location: Landscaping works under Phase-1 for IISER TVM campus, Thiruvananthapuram

NIT NUMBER: IISER-T/1401-2/17/2019-20 dated: 23-10-2019

Estimated cost put to tender	:	Rs. 20,85,684/-
(i) Earnest money	:	Rs. 41,714/-
(ii)		(To be returned after receiving Performance guarantee)
(iii) Performance Guarantee	:	5% of tendered value.
(iv) Security Deposit	:	2.5% of tendered/accepted value.

SCHEDULE 'C'

GENERAL RULES & DIRECTIONS:

Officer inviting tender Superintending Engineer,
IISER, THIRUVANANTHAPURAM.

Maximum percentage for quantity of items of work
To be executed beyond which rates are to be
Determined in accordance with Clauses 12.2 & 12.3: See below

Definitions:

2(v) Engineer-in-Charge	Engineer as authorized by IISER TVM
2(viii) Accepting Authority	Director, IISER THIRUVANANTHAPURAM
2(ix) Percentage on cost of materials and labour to cover all overheads and profits	15%
2(x) Standard Schedule of rates	CPWD Delhi Schedule of Rates 2018 plus cost Index enhancement & market rates
2(viii) Department	Indian institute of Science Education & Research, IISER, THIRUVANANTHAPURAM

No running account bill shall be paid for the work till the applicable labour licenses, registration with GST, EPFO, ESIC and BOCW Welfare board, whatever applicable are submitted by the contractor to the Engineer in charge.

Clause 7

Gross work to be done together with net payment /adjustment of advances for material collected, if any, since the last such payment for being eligible to interim payment Rs. 1.00 Lakhs

Clause 7A

Whether clause 7A shall be applicable: Yes.

Clause 10

List of testing equipment to be provided by the contractor at site lab. As per work requirements

Clause 10 A

Whether Clause 10 A shall be applicable : Applicable

Clause 10 B

Whether Clause 10 B shall be applicable : applicable

Clause 10B(i)

Whether Clause 10B (i) shall be applicable. : Applicable.

Clause 10B(ii)

Whether Clause 10B (ii) shall be applicable. : Not Applicable.

Clause 10 C

Component of labour expressed as percent of value of work : Applicable

Clause 10CA

: Applicable

S. No.	Materials covered under this Clause	Base price and its corresponding period of all the materials covered under clause 10CA i/c GST (In Rupees) March, 2017	Nearest Materials (other than cement*, reinforcement bars, the structural steel and POL) for which All India whole sale Price Index to be Followed
--------	-------------------------------------	--	--

CLAUSE 10CC

NOT APPLICABLE

Clause 10 CC to be applicable in contracts with stipulated period of completion exceeding the period shown in next column..... 60days

Schedule of component of other Materials, Labour, POL etc.

for price escalation.

Component of civil (except materials covered under Clause 10CA/Electrical Construction materials

expressed as percent of total value of work Xm -- %

Component of Labour

expressed as percent of total value of work. Y -- %

Component of P.O.L-

expressed as percent of total value of work. Z..... 0..... %

Clause 11

Specifications to be followed for execution work

- 1) Technical specification given in Tender documents.
- 2) CPWD standard specification 2009 Volume I & II with up to date correction slips for civil works.
- 2a) CPWD standard specification for internal Electrical works – 2013, external electrical services- 2007, DG set & Wet riser, sprinkler, specification-2006, Substation works Part IV-2013.
- 3) Indian Standard Specification
- 4) Manufactures specification
- 5) Engineer In charge decision.

Clause 12

Type of work	Project and original work	
12.2 & 12.3	Deviation Limit beyond which clauses 12.2 & 12.3 shall apply for building Superstructure work & other Associated Electro-mechanical works	30 %
12.5	(i) Deviation Limit beyond which clauses 12.2 & 12.3 shall apply for foundation work	30%

(Except items mentioned in earth work sub head in DSR and related items)

(ii) Deviation Limit for items mentioned in earth work
 Sub head of DSR or related items
 100
 %

Clause 16

Competent Authority for deciding The Director Indian institute of Science
 Reduced rates Education & Research, IISER
 THIRUVANANTHAPURAM

Clause 18

List of mandatory machinery, tools & plants - As per Annexure-II in the NIT
 To be deployed by the contractor at site at this cost: Condition of Contract.

Clause 25

Constitution of Dispute Redressal Committee- Building and Works Committee

Clause 34 (i)

Requirement of Technical Representative(s) and recovery rate to be affected from Contractor bill for non-deployment of technical staff at site of work:

S.N	Technical Representative(s)	Qualification & Discipline of the Technical representative(s)	Minimum Experience of the Technical representative(s)	Minimum Numbers to be employed at site for full duration of the project	Rate at which recovery shall be made from the contractor in the event of not fulfilling provision of clause 34(i)	
					Figure	Words
1	Engineers	Diploma in Civil engg	1 year	1	15000	Fifteen thousand only

Note:

1. Assistant Engineers retired from Government services who are holding Diploma will be treated at par with Graduate Engineers. Diploma holder with minimum 10 years' relevant experience with a reputed construction company can be treated at par with Graduate Engineers for the purpose of such deployment subject to the condition that such diploma holders should not exceed 50% of requirement of degree engineers.

2. The contractor shall submit a certificate of employment of the technical representative(s) (in the form of copy of Form -16 or CPF deduction issued to the Engineers employed by him) along with every account bill/final bill and shall produce evidence if at any times so required by the Engineer-in-charge.

3. The CV of technical persons shall be presented to Engineer in charge before deployment in above work for approval. Once inducted they will not be transferred or removed without the permission on Engineer in Charge. Exempted

Note:

1. Assistant Engineers retired from Government services who are holding Diploma will be treated at par with Graduate Engineers. Diploma holder with minimum 10 years' relevant experience with a reputed construction company can be treated at par with Graduate Engineers for the purpose of such deployment subject to the condition that such diploma holders should not exceed 50% of requirement of degree engineers.

2. The contractor shall submit a certificate of employment of the technical representative(s) (in the form of copy of Form -16 or CPF deduction issued to the Engineers employed by him) along with every account bill/final bill and shall produce evidence if at any times so required by the Engineer-in-charge.

LIST OF APPROVED MAKES

THE CONTRACTOR SHALL QUOTE HIS RATES ON THE BASIS OF THE PRICE OF BEST QUALITY PRODUCT OF THE BRAND/MAKE. IN ANY CASE PARTICULAR BRAND OF ITEM IS NOT ACCEPTABLE TO THE CLIENT THE CONTRACTOR SHALL SUPPLY ITEMS OF OTHER APPROVED BRANDS AT NO EXTRA COST.

LIST OF APPROVED MAKES FOR CIVIL WORKS

SL NO	MATERIAL	MAKES/MANUFACTURER
1	ANTI - TERMITE TREATMENT	OSOLIN, OR OTHER EQUIVALENT
2	CONCRETE ADDITIVE	SIKA/ STP/CICO/PIDILITE/ FOSROC/FAIRMATE/ MC BOUCHEMIE/ CHOKESY
3	CLASSIC DARK BLUE HEAT REFLECTIVE GLASS	GLAVERBEL/ ASAHI INDIA SAFETY/ SAINT GOBAIN/ GLAVERMAS
4	ADHESIVE FOR DOOR WORK	FEVICOL/VAMICOL/DUNLOP
5	DASH FASTENERS	HILTI/ FAISCHER/ BOSCH
6	DOOR LOCKS	GODREJ/ HARRISON/ LINK
7	DOORS & WINDOWS FIXTURES/ FITTING	EVERLITE / ARGENT/ CLASSIC/ CROWN/ EARL BIHARI
8	EXTRUDED POLYSTYRENE BOARD	STYROFOAM BY DOW CHEMICALS/ INSUBOARD BY SUPREME INDUSTRIES
9	FIRE DOORS	NAVAIR/ SHAKTI - MET DOR/ GODREJ/ PROMAT/ SINGUM
10	FLUSH DOOR SHUTTERS	DURO/GREENPLY/CENTURY/
11	HARDWARE	ARKAY/ GODREJ/ D-LINE/ CARL-F
12	LAMINATES	DURO/ CENTURY/ GREENLAM/ FORMICA/ DECOLAM/ EURO,/ALPRO
13	PLYWOOD/ BLOCKBOARD/ PLY BOARD	DURO/ GREENPLY/CENTURY/ KITPLY/ GREENLAM/ NOVAPAN/ MARRINO/ GREENPLY/ EURO/ALPRO
14	PRE- LAMINATED PARTICLE BOARD	ANCHOR/ NOVAPAN/ CENTURY/ GREEN PLY/ARCHIDPLY/ ALPRO
15	PVC CONTINUOUS FILLET FOR	ROOP/ ANAND/ FOREX PLASTIC/ NAGALIA/









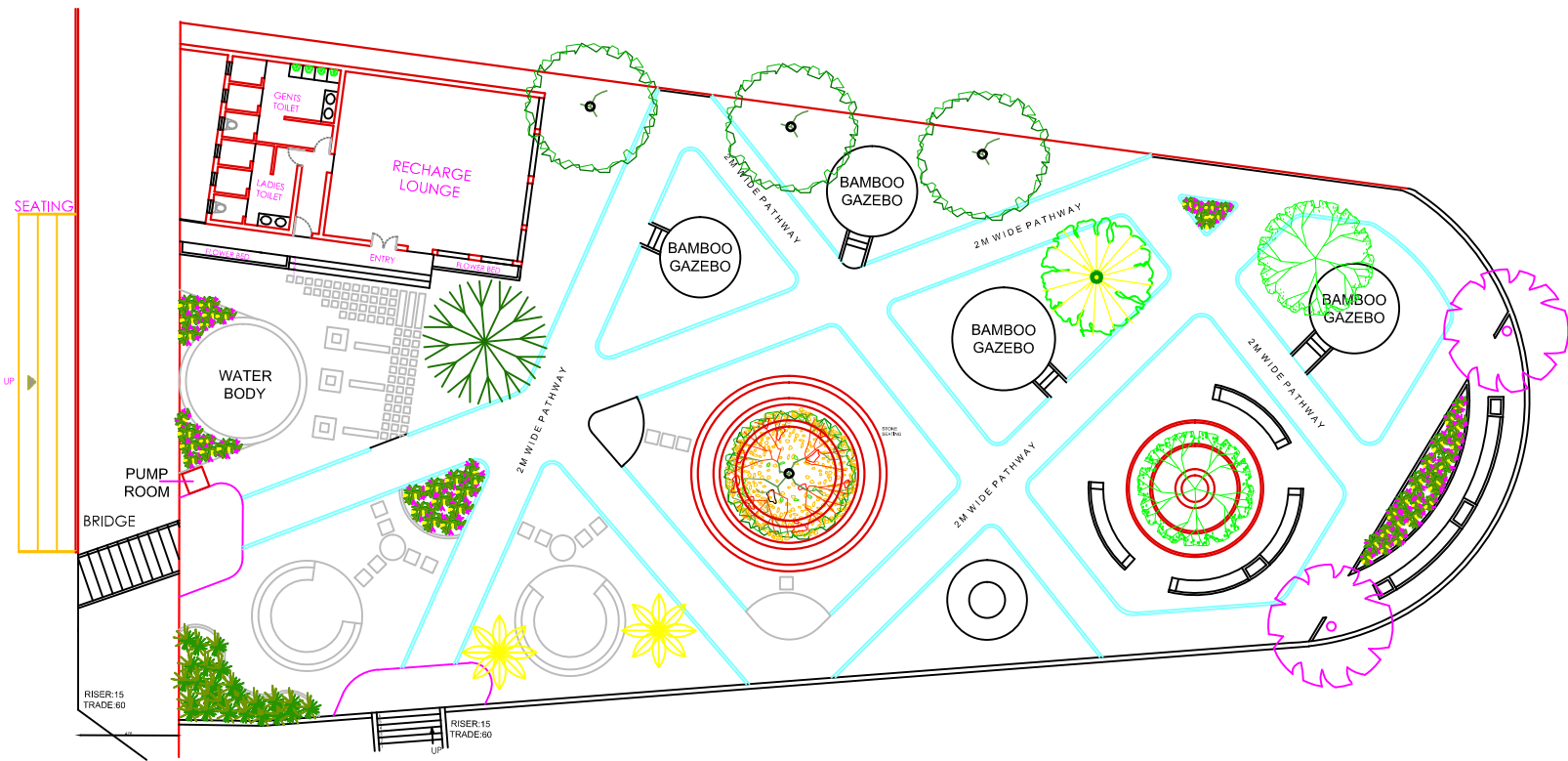





SL NO	MATERIAL	MAKES/MANUFACTURER
	PERIPHERY PACKING OF GLAZINGS/ STRUCTURAL/ GLAZINGS	TRADING COMPANY
16	STAINLESS STEEL BOLTS, WASHERS AND NUTS	KUNDAN/ PUJA/ ATULI
17	STAINLESS STEEL FRICTION/SPRING HINGES	EARL BIHARI/ SECURISTYLE/ EBCO / ARKAY
18	STAINLESS STEEL SCREW FOR FABRICATION AND FIXING OF WINDOWS	KUNDAN/ PUJA/ ATUL/ ARKAY
19	M.S. PIPE / G.I PIPE	JINDAL/ HISAR/ PRAKASH- SURYA/ BST/ KALINGA/ TATA / TT SWASTIK
20	CERAMIC TILES	JOHNSON/ SOMANY/ KAJARIA/ SPARTEK/ NITCO/ ORIENT/ BELL CERAMICS
21	CERAMIC TILES ADHESIVE	CICO/ BELL/ PIDILITE/BAL ENDURA/ BASF/SIKA
22	COMPRESSED CHEQUERED TILES	JOHNSON/ SOMANY/ KAJARIA/ SPARTEK/ NITCO/ ORIENT/ BELL CERAMICS
23	EPOXY SLF FLOORING	SIKA/ STONHARD/ STP/ BASF/ PIDILITE
24	VACUUM DEWATERED FLOORING	TREMIX/ SUN BUILD/ AVCON TECHNICS
25	GLAZED TILES	BELL/ SOMANY/ JOHNSON/ KAJARIA/ CERA/ SPARTEK/ORIENT / NITCO
26	PVC FLOORING	TARKETT FLOORS/ LG FLOORS/ GERFLOR/ RESPONSIVE/ PREMIER VINYL FLOORING /REGENT / ARMSTRONG
27	VITRIFIED TILES	NITCO/ NAVEEN/ BELL/ H.R. JOHNSON/ KAJARIA/ SOMANY / EURO
28	WOODEN LAMINATED FLOORING	FAUS/ SCHEIT/ KAIND/ NITCO/EURO/PARGO
29	WATER PROOFING/INSULATION	M/S IWL (INDIA) LTD/ M/S LLOYD INSULATIONS INDIA LTD./ MIS CHEMISOL ADHESIVE PVT. LTD. , MUMBAI/ (CHEMISTIK) TEXAS LTD./FOSROC /SIKA / CICO /MC BOUCHEME

SL NO	MATERIAL	MAKES/MANUFACTURER
30	WATER PROOFING AGENCIES	SHALIMAR TAR PRODUCTS/ IWL (INDIA) LTD. / LLYOD INSULATIONS INDIA LTD. / CHEMISOL ADHESIVE PVT. LTD. MUMBAI/ INDIAN WATER PROOFING /OVERSEAS WATER PROOFING/ (CHEMISTIK) TEXAS LTD/ FOSROC /SIKA / CICO/ MC BOUCHEME
31	METAL SHEET ROOFING	M/S LLOYD INSULATIONS INDIA LTD./ M/S KIRBY
32	CEMENT BASED PAINTS	<p>ALL TYPES OF PAINTS I.E. CEMENT BASED PAINTS, OIL BOUND DISTEMPER, ACRYLIC PAINTS, PLASTIC EMULSION PAINTS ETC SHALL BE FIRST QUALITY OF MAKES ICI, BERGER, ASIAN, SHALIMAR, GOODLAS NAROLAC AND JOHNSON & NICHOLSAN MAKE, FOR CEMENT BASED PAINT ADD SNOWCEM PLUS AND TATACEM MAKE.</p>
33	CEMENT PAINT	
34	DRY DISTEMPER	
35	OIL BOUND DISTEMPER/ACRYLIC WASHABLE DISTEMPER	
36	OTHER PAINTS/ PRIMER	
37	PLASTIC EMULSION PAINT	
38	SYNTHETIC ENAMEL PAINTS	
39	RESIN BASED PAINTS	
A	EXTERNAL EMULSION PAINT	
40	TEXTURE PAINT	BERGER/ J & N/ SPECTRUM/ UNILITE HERITAGE/ ASIAN / SHALIMAR/ ICI
41	CLEAR GLASS/ CLEAR FLOAT GLASS/ TOUGHENED GLASS	MODI/ SAINT GOBAIN (SG)/ ASAHI INDIA SAFETY/ GSC/ TATA/ ATUL
42	EPOXY PAINT	NEROLAC/ SHALIMAR/ CICO/ FAIRMATE/ SIKA/BASF/ BERGER/ ASIAN / PIDILITE
43	GYPSUM FALSE CEILING	GYPSUM FALSE CEILING GYPSUM INDIA LTD./BEARL GYPSUM/ INDIA GYPSUM/ LAFFARGE /ST. GOBAIN (GYPROC)
44	METAL FALSE CEILING	NITTOBO/ ARMSTRONG/ DURLUM/ TRAC/ UNIMENT
45	MINERAL FIBRE CEILING	ARMSTRONG/ NITTOBO/ DAIKEN

SL NO	MATERIAL	MAKES/MANUFACTURER
46	POLYSULPHIDE SEALANT	PIDILITE/ FOSROC/ CHOKSEY/ CHEMATAL RAI/ CICO /SIKA, MC BOUCHEMIE, BASF
47	POWDER COATING MATERIAL PURE POLYESTER	JOTUN/ BERGER/ GOODLASS NEROLAC
48	ALUMINIUM ACCESSORIES AND HARDWARE	CLASSIC/ ARGENT/ OXFORD/ NEWLITE/ CROWN/ EBCO / EARL BIHARI
49	ALUMINIUM DIE- CAST HANDLES & TWO POINT LOCKING KIT	GIESSE/ SECURISTYLE/ ALU-ALPHA
50	ALUMINIUM EXTRUSION	INDAL/ MAHAVIR/ HINDALCO/ JINDAL/
51	ALUMINIUM FABRICATORS	M/S. INTERNATIONAL GLASS HOUSE, M/S. AGV ALFA LAB LTD., M/S. CONSOLIDATED ENGG. COMPANY/ M/S. AJIT (INDIA) PVT. LTD. / CALCO / ALKARMA
52	DOOR CLOSER / FLOOR SPRING	DOORKING/EVERITE/ HARDWYN/MASTER
53	DOOR SEAL- WOOLPILE WEATHER STRIP	ANAND REDDIPLEX/ ENVIROSEAL
54	GLASS FOR ALUMINIUM DOORS/ WINDOWS	MODI FLOAT GLASS (INDIA) SAINT GOBAIN / ASAHI INDIA SAFETY GLASS LTD./ ATUL
55	GLASS DOORS (MOTORISED)	AUTODOOR INDUSTRIES/ DORMA/ ERREKA
56	SUNKEN PORTION TREATMENT	CHOKSEY/ SIKA/ CICO,MC BOUCHEMIE/ MC BOUCHEMIE / BASF
57	CEMENT	ACC (ASSOCIATED CEMENT CO.) L&T/ GUJRAT AMBUJA CEMENT / BIRLA CORP. LTD. (CEMENT DIVN.) JK CEMENT/ JAYPEE REWA CEMENT, / GRASIM CEMENT / SHREE CEMENT / LAKSHMI CEMENT / CENTURY / LAFFARGE / PRISM / INDIA CEMENT / BANGUR
58	READY MIX CONCRETE	LAFARGE/ BIRLA/ ACC/ GODREJ/ UNITECH/(RMC) LTD./ L&T / COROMANDAL/ POABSONS/COMPUTRISED BMC PLANT BY CONTRACTOR
59	REINFORCEMENT STEEL	SAIL/ RASHTRIYA ISPAT NIGAM LTD. / TISCO/ IISCO

SL NO	MATERIAL	MAKES/MANUFACTURER
60	CALCIUM SILICATE BOARDS	HILUX / AEROLITE
61	CACIUM SILICATE TILES	AEROLITE / HILUX .
62	STAINLESS STEEL CLAMPS	HILTI/ INTELLOTECH/ KONCEPT
63	E.P.D.M. GASKETS	ANAND REDDIPLEX/ ENVIRO SEALS
64	FLEXI TAPE	NORTON/ BIZZARE
65	GLASS FIBRE ACOUSTICAL TILES	ECOPHON/ UP TWIGA
66	GLASS WOOL	ROCKWOOL/ UP TWIGA/ LLOYD INSULATION
67	SILICON SEALANTS (I) WEATHER SEALANT (II) STRUCTURAL GLAZING SEALANT	GE- SILICON/ PIDILITE/CHOKSEY/ WACKER/ FORSOC/ CICO/ DOW CORNING/ SIKA/
68	WHITE CEMENT	BIRLA WHITE/ J.K. / GRASIM



LEGEND :		TREES
	CAS FIS	CASSIA FISTULA height varies 3000m-3,500 100mm- 150mm trunk caliper
	SPA COM	SPATHODIA COMPANULATA 4500mm- 5000mm overall ht 50-75mm trunk caliper
	PLU ACT	PLUMERIA ACUTIFOLIA 2500-3500mm overall ht 50-75mm trunk caliper
	MIL HOR	MILLIGTONIA HORTENSIS 3500 mm overall ht 40-60mm trunk caliper
	PLU RUB	PLUMERIA RUBRA Min 3000mm Overall ht Specimen Tree @ 50mm trunk caliper Multi Branching
	BRA ACT	BRASSIA AGTINOPHYLLA Min 2500-3000mm Overall ht Specimen Tree @ 50mm trunk caliper Multi Branching
	BAU BLA	BAUHINIA BLACKIANA 3600-4600 mm overall ht 40-60mm trunk caliper
	TABE BLA	TABELLARIA ROSEA 3500-4500 mm overall ht 40-60mm trunk caliper
	GUL TR	GULMOGHAR TREE 3500-5000 mm overall ht 40-60mm trunk caliper
	ALI SCH	ALIBISTONIA SCHOLARIS 3000-3500 mm overall ht 40-75mm trunk caliper
	AZA IND	AZADIRACHTA INDICA 3800-4000 mm overall ht 40-75mm trunk caliper
	SAM SAM	SAMANIA SAMAN 3500-4500 mm overall ht 40-75mm trunk caliper
	PEL PTE	PELTOPHORUM PTEROCARPUM 4000-4500 mm overall ht 40-75mm trunk caliper
		SYZYGIUM JAMBOS 700-1000 mm overall ht 40-75mm trunk caliper (ROSE APPLE TREE)
		PSIDIA GUAJAVA 750-1000 mm overall ht 40-75mm trunk caliper (GUAVA TREE)

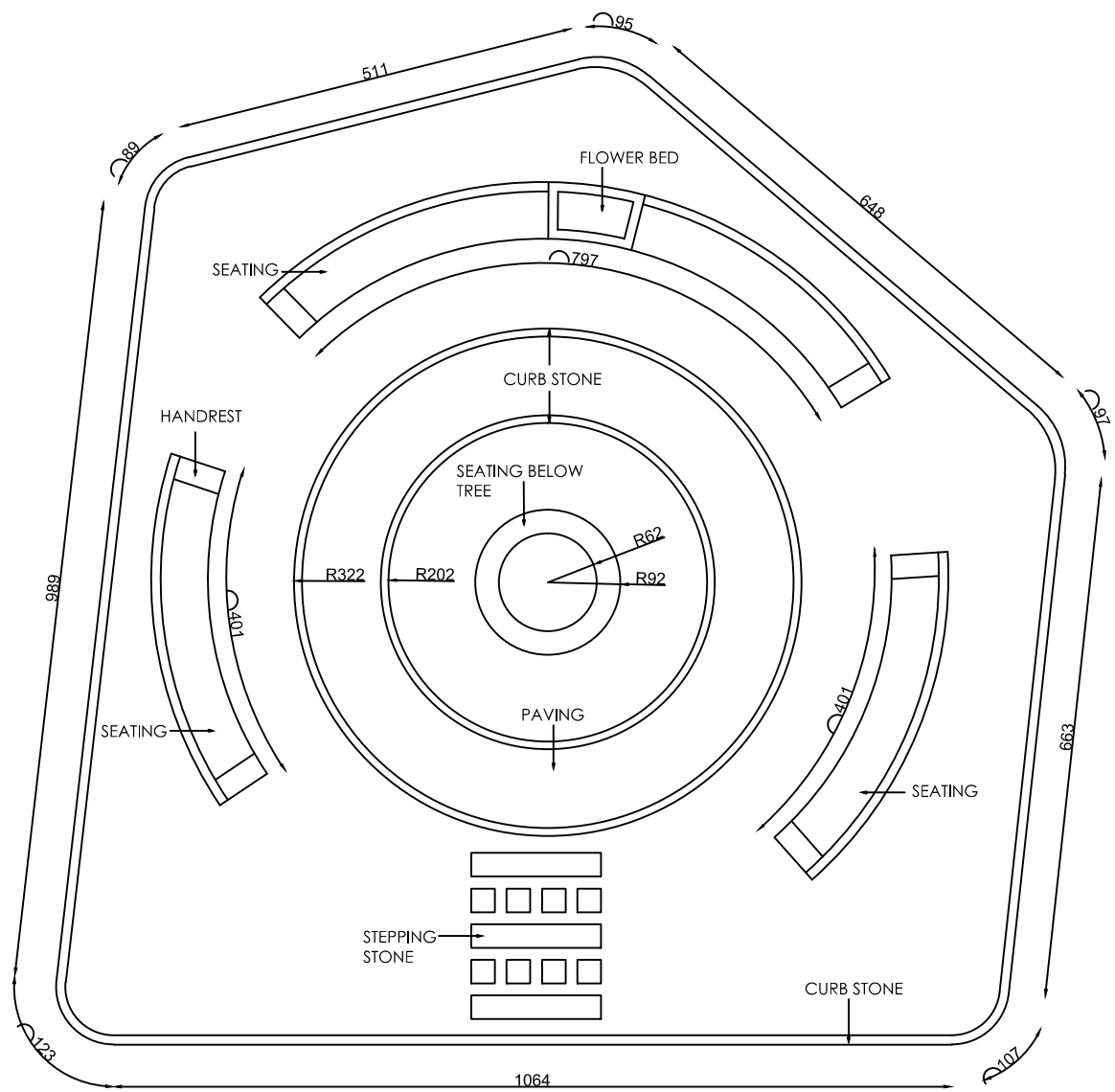
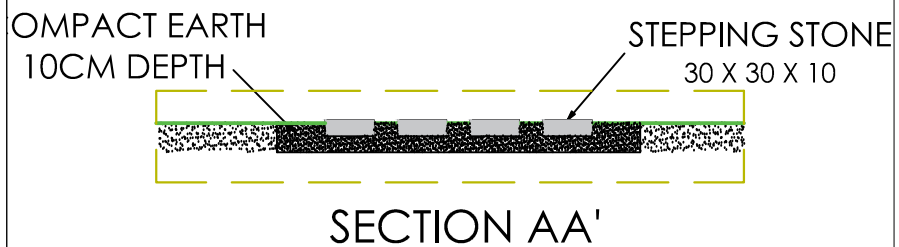
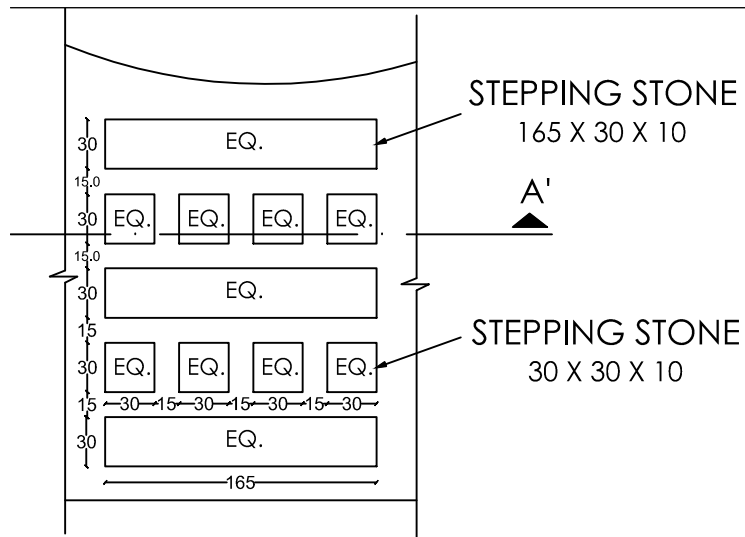
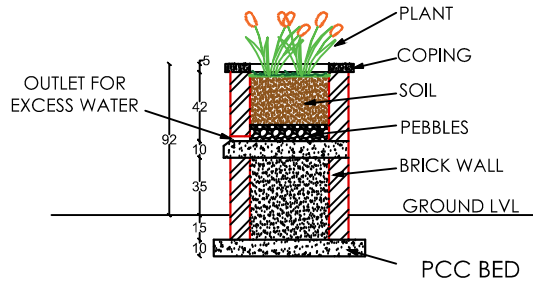
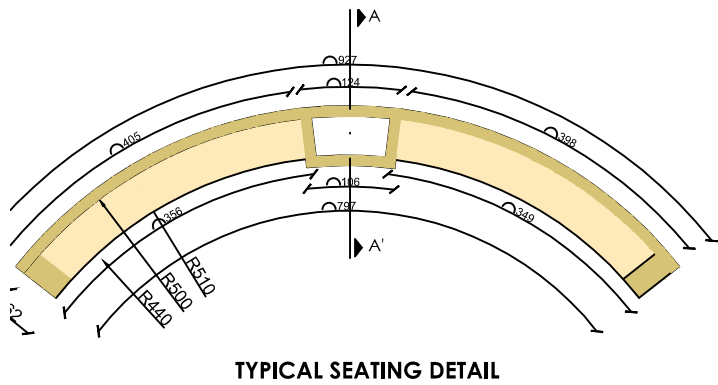

GENERAL N
1. Do not Sc
2. All Dimen
otherwise.
3. All dimen
proceedin
4. All Levels

BT
F

TOTAL
SCHEDU
S.NO TY

PRO
SPA

TEC

TI
TE

e-mai
web

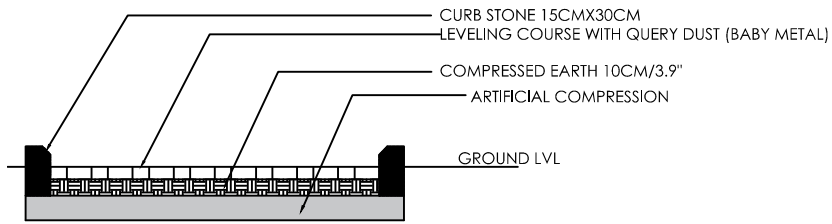

PATHWAY DETAIL
C-C WIDTH = 200CM

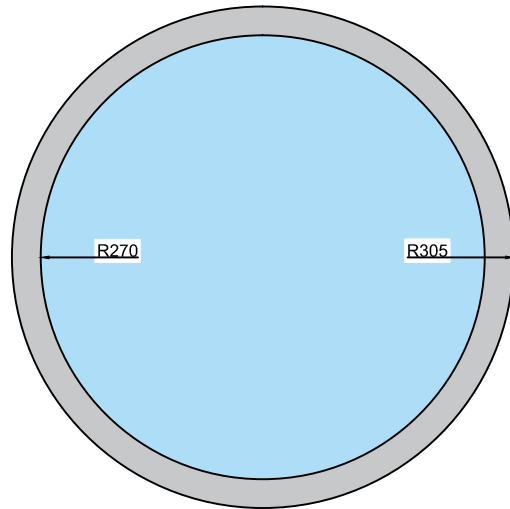
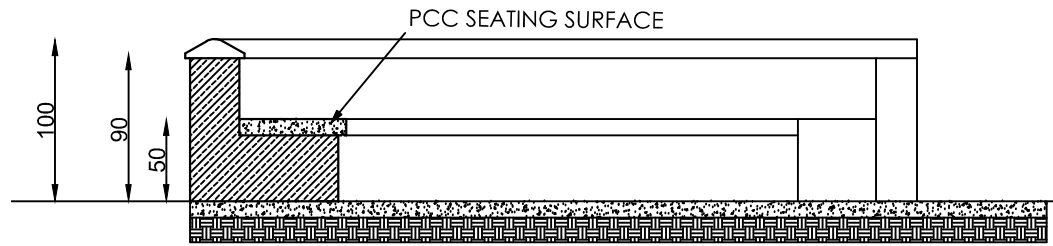

35 — 540 — 35
610
PLAN

WATER POND

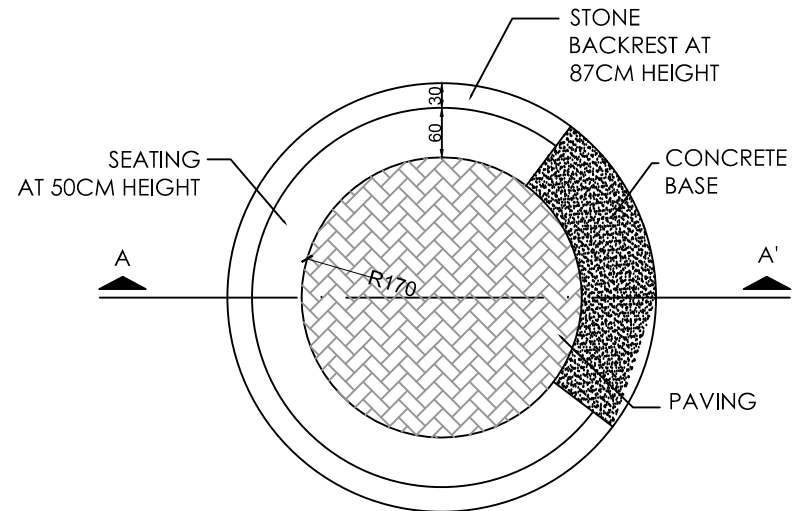

PLAN
CIRCULAR SEATING

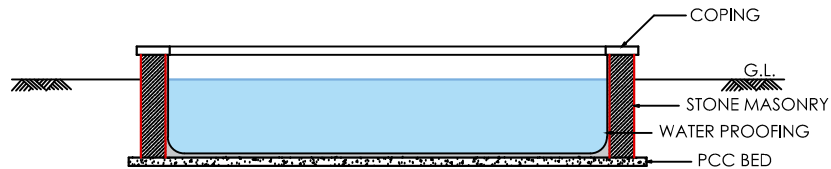

SECTION AA'

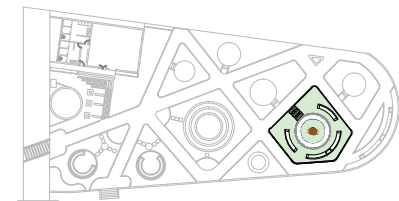

KEYPLAN
SCALE 1:150

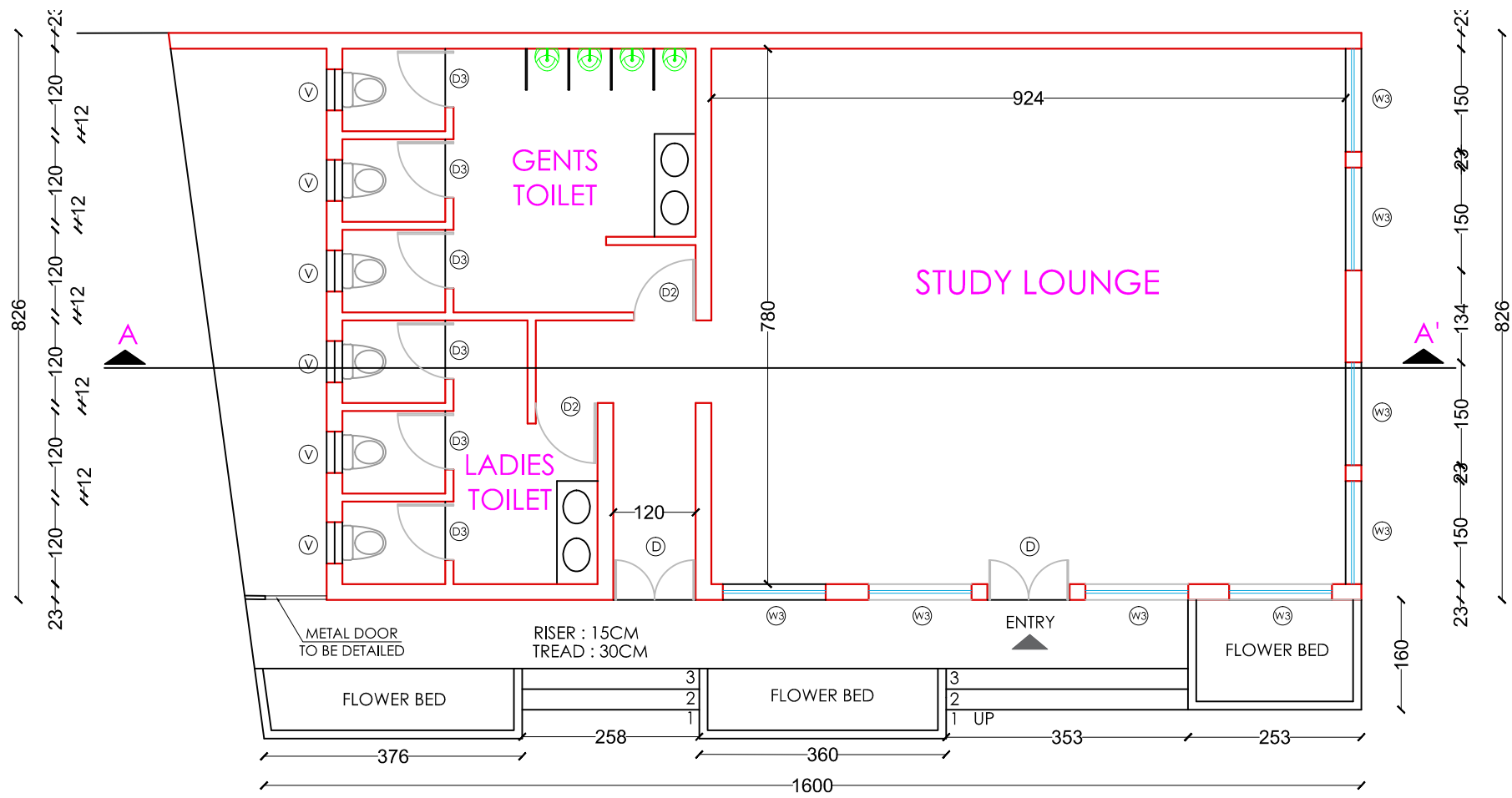

PLAN
SCALE 1:10

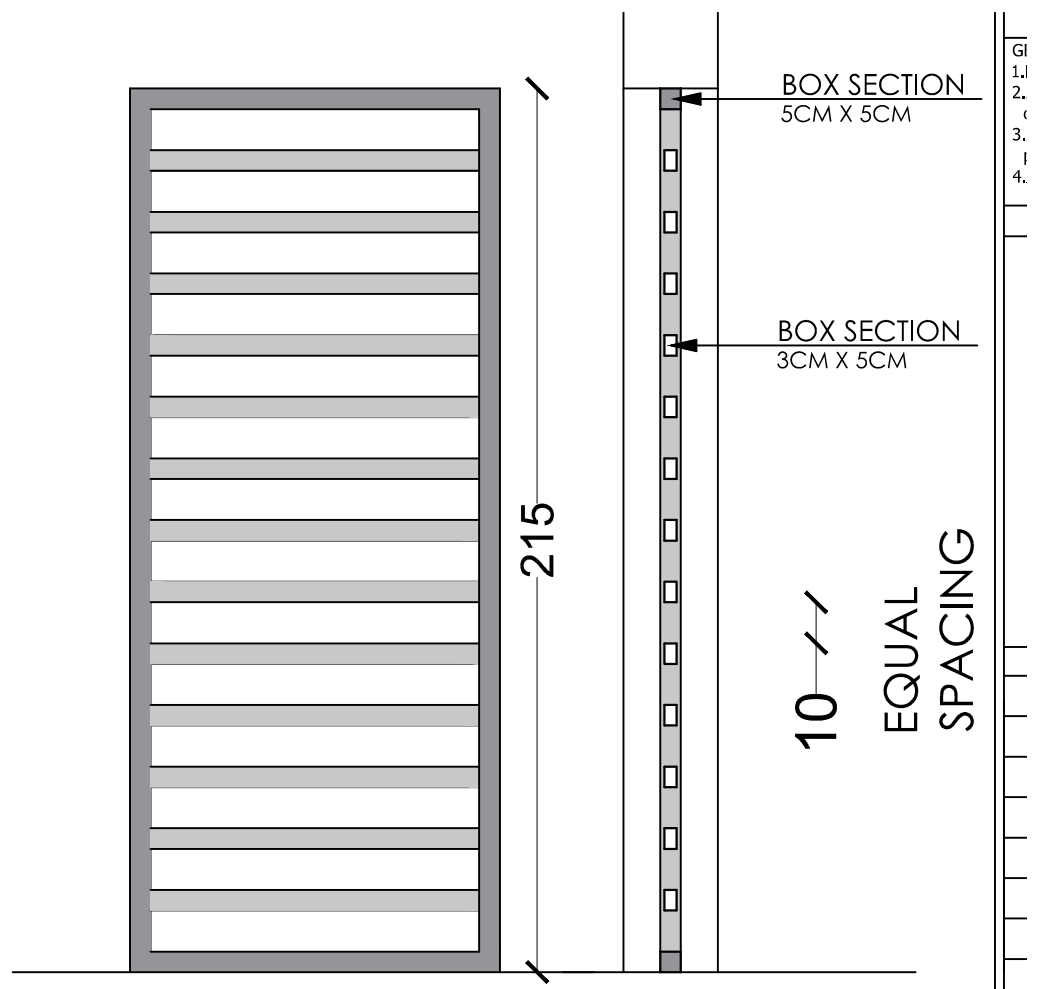

ELEVATION **SECTION**

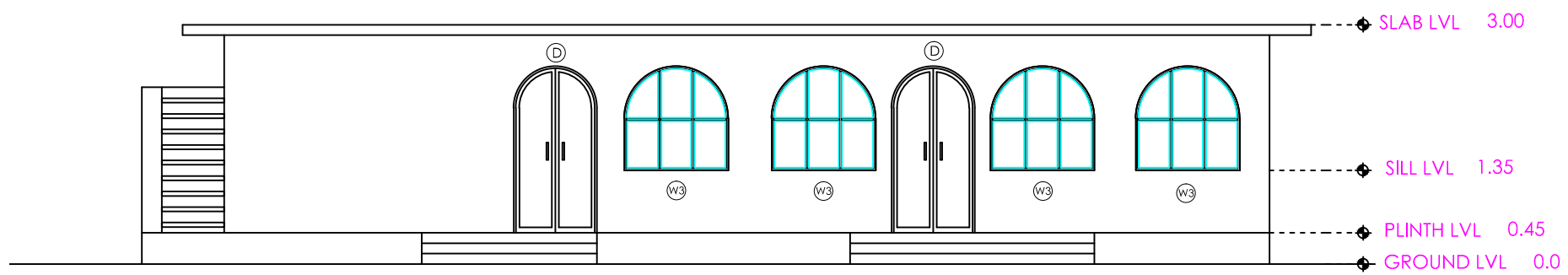

ELEVATION
SCALE 1:10

METAL DOOR DETAILS
SCALE 1:2

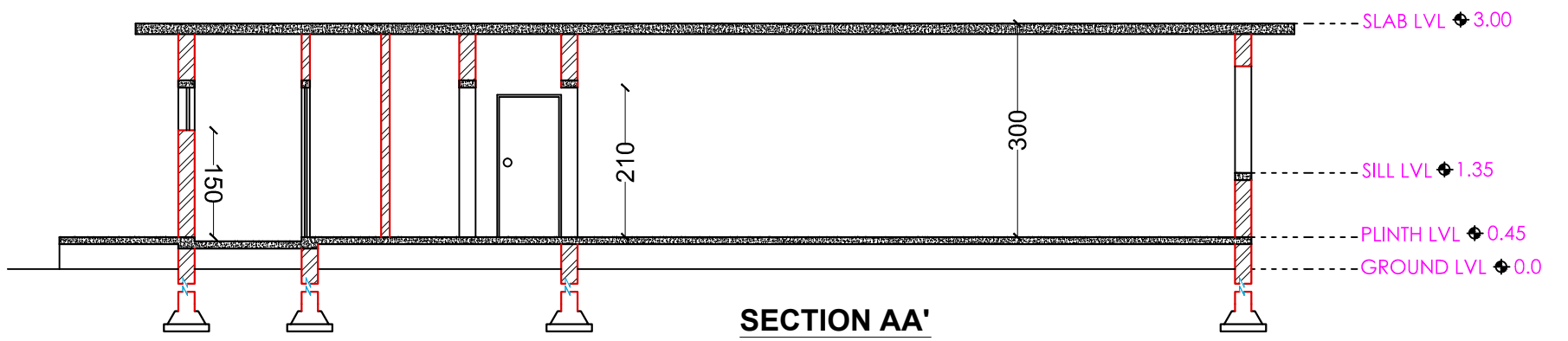

SECTION AA'
SCALE 1:10

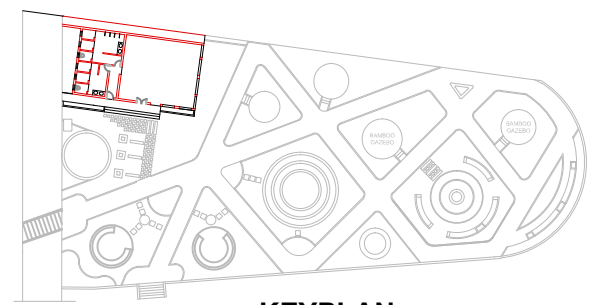

KEYPLAN
SCALE 1:150